

**GENERAL INFORMATION**

**WOOD-KNOCKER® II+ AND PAN-KNOCKER™ II+**

Concrete Inserts

**PRODUCT DESCRIPTION**

Wood-Knocker II+ and Pan-Knocker II+ concrete inserts are installed onto forms used to support newly poured concrete floor slabs, roof slabs or walls. The concrete inserts are specifically designed to provide hanger attachments for mechanical, electrical, plumbing (MEP) and fire protection.

When the forms are stripped, the color-coded flange is visibly embedded in the concrete surface. The inserts allow the attachment of steel threaded rod or threaded bolts in sizes ranging from 1/4" to 3/4" in diameter. The sturdy base and rib design minimizes the chance of inserts accidentally being hit out of place after attachment to the forms. The impact plate offers resistance to rotation within the concrete as a steel threaded rod or threaded bolt is being turned during installation.

A push-in thread version is also available which does not require turning the threaded rod or threaded bolt during installation which can be ideal for applications such as mounting prefabricated hardware and hanger assemblies.

**GENERAL APPLICATIONS AND USES**

- Hanging Pipe and Sprinkler Systems
- HVAC Ductwork and Strut Channels
- Suspending Trapeze and Cable Trays
- Cast-In Pre-installed Anchoring Points
- Distribution Systems / Utility Lines
- Conduit and Lighting Systems
- Cracked and Uncracked Concrete
- Seismic Qualification (SDC A - F)

**FEATURES AND BENEFITS**

- + Fast and simple to install, low installed cost
- + Sturdy base design resists inserts from being kicked over after placement
- + Color coded by size for simple identification, can be further marked by trade and/or utility
- + Inserts can be installed in form pours only 3.5" thick; low profile (LP) inserts can be installed in form pours only 2.5" thick (see installation details)
- + Suitable for seismic and wind loading (see design information)
- + Multi thread inserts allow for multiple diameters using the same part
- + All sizes of multi thread inserts have performance data for tension and shear loading
- + Push-In thread version does not require turning threaded rod elements during installation

**APPROVALS AND LISTINGS**

- International Code Council, Evaluation Service (ICC-ES), ESR-3657 for concrete
- Code compliant with the 2021 IBC/IRC, 2018 IBC/IRC, 2015 IBC/IRC, and 2012 IBC/IRC
- Tested in accordance with ASTM E488 and ICC-ES AC446 for use in cracked and uncracked concrete and with the design provisions of ACI 318 (Strength Design method)
- Evaluated and qualified by an accredited independent testing laboratory for recognition in cracked and uncracked concrete including seismic and wind loading
- Underwriters Laboratories (UL Listed) - File No. EX1289 and VFXT7.EX1289, Also UL tested and recognized for use in air handling spaces (i.e. plenum rated locations) in accordance with UL 2043; as referenced by UL 203 for pipe hanger equipment
- FM Approvals (Factory Mutual), Class Numbers 1951, 1952, 1953 for pipe hanger components – see FM Approval Guide

**GUIDE SPECIFICATIONS**

CSI Divisions: 03 15 19 - Cast-In Concrete Anchors and 03 16 00 - Concrete Anchors. Concrete inserts shall be Wood-Knocker II+ or Pan-Knocker II+ as supplied by DEWALT, Towson, MD. Anchors shall be installed in accordance with published instructions and the Authority Having Jurisdiction.

**SECTION CONTENTS**

General Information..... 1  
 Material Specifications ..... 2  
 Installation Instructions ..... 2  
 Installation Specifications ..... 3  
 Performance Data (ASD)..... 5  
 Strength Design Information ..... 6  
 Design Strength Tables (SD) ..... 10  
 Ordering Information..... 13



WOOD-KNOCKER II+ FORM INSERT



PAN-KNOCKER II+ FORM INSERT 'NO NAIL' VERSION OF WOOD-KNOCKER II+



WOOD-KNOCKER II+ FORM INSERT PUSH-IN THREAD



PAN-KNOCKER II+ FORM INSERT PUSH-IN THREAD

**ANCHOR MATERIALS**

- Carbon Steel and Engineered Plastic

**ROD/ANCHOR SIZE RANGE (TYP.)**

- 1/4" through 3/4" diameters (UNC)

**INSERT VERSIONS**

- Thread-In
- Push-In

**SUITABLE BASE MATERIALS**

- Normal-weight Concrete
- Lightweight Concrete



**MATERIAL SPECIFICATIONS**

**Wood-Knocker II+ and Pan-Knocker II+**

Anchor Component	Component Material
Insert Body	AISI 1008 Carbon Steel or equivalent
Plastic sleeve	Engineered Plastic (polypropylene)
Zinc Plating (metal components)	ASTM B633 (Fe/Zn5) Min. plating requirements for mild service condition

**Material Properties for Common Threaded Rods**

Description	Steel Specification (ASTM)	Threaded Rod Diameter (inch)	Minimum Yield Strength, $f_y$ (ksi)	Minimum Ultimate Strength, $f_u$ (kst)
Standard Carbon Steel	A36 or ASTM F1554, Grade 36	1/4 to 3/4	36.0	58.0
High Strength Carbon Steel	A193, Grade B7	1/4 to 3/4	105.0	125.0

Inserts may be considered for use in conjunction with all grades of continuously threaded carbon steel (all-thread) that comply with code reference standards and that have thread characteristics comparable with ANSI B1.1 UNC Coarse Thread Series.

**INSTALLATION INSTRUCTIONS**

**Installation Instructions for Wood-Knocker II+ Thread-In**

**POSITION**

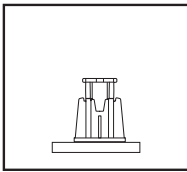

**Step 1**  
Position insert on formwork plastic down.

**DRIVE**

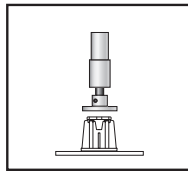

**Step 2**  
Drive insert head down until head contacts plastic (e.g. Wood-Knocker installation tool, hammer).

**PREPARE**

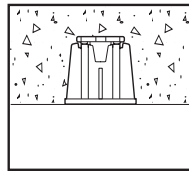

**Step 3**  
After formwork removal, remove nails as necessary (e.g. flush mounted fixtures).

**ATTACH**

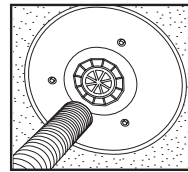

**Step 4**  
Guide threaded rod/bolt through plastic thread seal cover. Turn until steel element fully threaded. Attach fixtures as applicable.

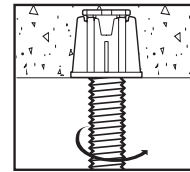

**Installation Instructions for Wood-Knocker II+ Push-In**

**POSITION**

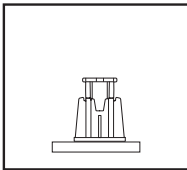

**Step 1**  
Position insert on formwork plastic down.

**DRIVE**

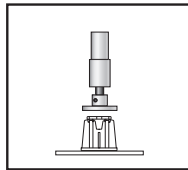

**Step 2**  
Drive insert head down until head contacts plastic (e.g. Wood-Knocker installation tool, hammer).

**PREPARE**



**Step 3**  
After formwork removal, remove nails as necessary (e.g. flush mounted fixtures).

**ATTACH**

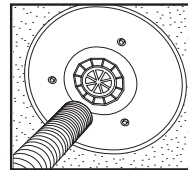

**Step 4**  
Guide threaded rod/bolt through plastic thread seal cover. Push in until steel element is fully seated. Attach fixtures as applicable.

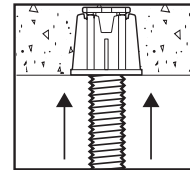

Note: for UL listing a nut must be installed snug against the insert.

**Installation Instructions for Pan-Knocker II+ Thread-In**

**POSITION**

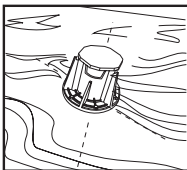

**Step 1**  
Position insert on formwork plastic down.

**MOUNT**

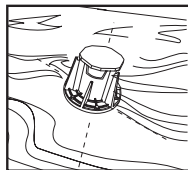

**Step 2**  
Mount/secure insert to formwork through plastic base (e.g. with screws, pins).

**PREPARE**

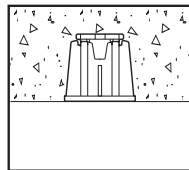

**Step 3**  
After formwork removal, remove pins or screws as necessary (e.g. flush mounted fixtures).

**ATTACH**

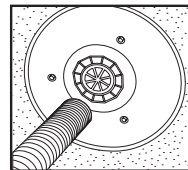

**Step 4**  
Guide threaded rod/bolt through plastic thread seal cover. Turn until steel element fully threaded. Attach fixtures as applicable.

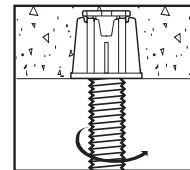

**Installation Instructions for Pan-Knocker II+ Push-In**

**POSITION**

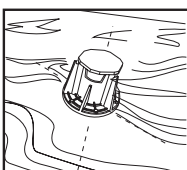

**Step 1**  
Position insert on formwork plastic down.

**MOUNT**

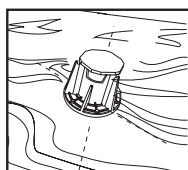

**Step 2**  
Mount/secure insert to formwork through plastic base (e.g. with screws, pins).

**PREPARE**

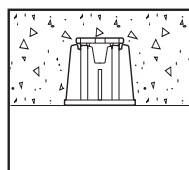

**Step 3**  
After formwork removal, remove pins or screws as necessary (e.g. flush mounted fixtures).

**ATTACH**

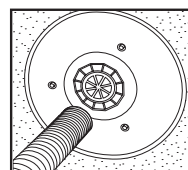

**Step 4**  
Guide threaded rod/bolt through plastic thread seal cover. Push in until steel element is fully seated. Attach fixtures as applicable.

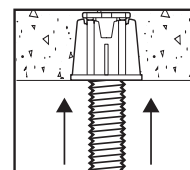

Note: for UL listing a nut must be installed snug against the insert.

**INSTALLATION SPECIFICATIONS**

**Wood-Knocker II+ Inserts for Form Pour Concrete**

**Pan-Knocker II+ Inserts for Form Pour Concrete**

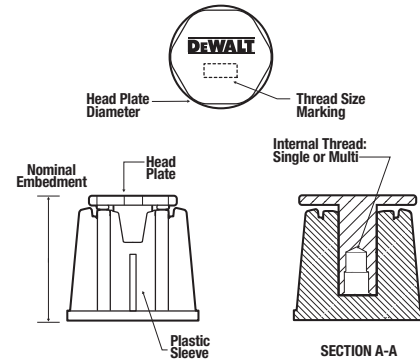
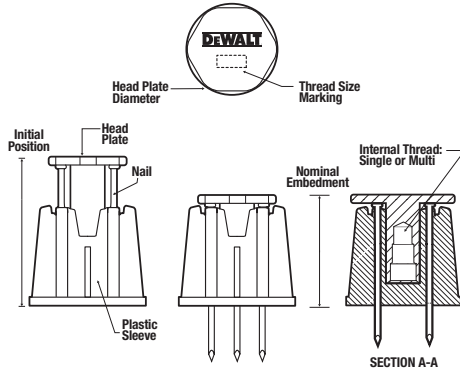

**Installation Specifications for Wood-Knocker II+ and Pan-Knocker II+ Single Thread Inserts<sup>1</sup>**

Insert Dimension / Property	Symbol	Units	Nominal Rod/Anchor Size						
			1/4" (LP)	3/8" (LP)	1/4"	3/8"	1/2"	5/8"	3/4"
Outside diameter of steel insert body	d <sub>a</sub>	in. (mm)	0.5 (13)		0.7 (18)			1.0 (25)	
Insert head plate diameter	d <sub>hp</sub>	in. (mm)	1.30 (33)		1.50 (38)			1.75 (45)	
Plastic sleeve diameter	d <sub>s</sub>	in. (mm)	2 (51)		2-3/8 (60)			2-3/8 (60)	
Nominal embedment depth	h <sub>nom</sub>	in. (mm)	1-1/2 (38)		2 (51)			2 (51)	
Effective embedment depth	h <sub>ef</sub>	in. (mm)	1.25 (32)		1.75 (45)			1.75 (45)	
Minimum member thickness	h <sub>min</sub>	in. (mm)	2-1/2 (64)		3-1/2 (89)			3-1/2 (89)	
Minimum spacing distance	s <sub>min</sub>	in. (mm)	4d <sub>a</sub>		4d <sub>a</sub>			4d <sub>a</sub>	
Minimum edge distance	c <sub>min</sub>	in. (mm)	0.5d <sub>hp</sub> + 3/4 (19)		0.5d <sub>hp</sub> + 3/4 (19)			0.5d <sub>hp</sub> + 3/4 (19)	
Insert head plate thickness	t <sub>hp</sub>	in. (mm)	1/8 (3)		1/8 (3)			1/8 (3)	
UNC internal thread size	-	TPI	1/4-20	3/8-16	1/4-20	3/8-16	1/2-13	5/8-11	3/4-10
Approx. internal thread length	-	in.	5/16	7/16	3/8	1/2	5/8	3/4	7/8
Approx. gap between plastic sleeve opening and start of internal thread, after setting	-	in.	5/16		3/8				

1. Inserts have internal thread size designations for coarse threads matching the nominal rod / anchor size.

**Installation Specifications for Wood-Knocker II+ and Pan-Knocker II+ Multi Thread Inserts<sup>1</sup>**

Insert Dimension / Property	Symbol	Units	Nominal Rod/Anchor Size													
			1/4" & 3/8" Multi (LP)		1/4" & 3/8" Multi		1/4" & 3/8" & 1/2" Multi		3/8" & 1/2" Multi		3/8" & 1/2" & 5/8" Multi		5/8" & 3/4" Multi			
Outside diameter of steel insert body	d <sub>a</sub>	in. (mm)	0.5 (13)		0.7 (18)		1.0 (25)									
Insert head plate diameter	d <sub>hp</sub>	in. (mm)	1.30 (33)		1.50 (38)		1.75 (45)									
Plastic sleeve diameter	d <sub>s</sub>	in. (mm)	2 (51)		2-3/8 (60)		2-3/8 (60)									
Nominal embedment depth	h <sub>nom</sub>	in. (mm)	1-1/2 (38)		2 (51)		2-3/8 (60)									
Effective embedment depth	h <sub>ef</sub>	in. (mm)	1.25 (32)		1.75 (45)		2.25 (57)									
Minimum member thickness	h <sub>min</sub>	in. (mm)	2-1/2 (64)		3-1/2 (89)		3-1/2 (89)									
Minimum spacing distance	s <sub>min</sub>	in. (mm)	4d <sub>a</sub>		4d <sub>a</sub>											
Minimum edge distance	c <sub>min</sub>	in. (mm)	0.5d <sub>hp</sub> + 3/4 (19)		0.5d <sub>hp</sub> + 3/4 (19)		0.5d <sub>hp</sub> + 3/4 (19)									
Insert head plate thickness	t <sub>hp</sub>	in. (mm)	1/8 (3)		1/8 (3)		1/8 (3)									
UNC internal thread size	-	TPI	1/4-20	3/8-16	1/4-20	3/8-16	1/4-20	3/8-16	1/2-13	3/8-16	1/2-13	5/8-11	5/8-11	3/4-10		
Approx. internal thread length	-	in.	5/16	7/16	3/8	1/2	5/16	3/8	1/2	7/16	9/16	3/8	1/2	5/8	3/4	
Approx. gap between plastic sleeve opening and start of internal thread, after setting	-	in.	7/8	5/16	1	5/16	1-7/16	15/16	5/16	1	5/16	1-11/16	1-1/16	5/16	1-3/16	5/16

1. Inserts have internal thread size designations for coarse threads matching the nominal rod / anchor size.

**MECHANICAL ANCHORS**

**WOOD-KNOCKER® II+/PAN-KNOCKER™ II+**

TECHNICAL GUIDE – MECHANICAL ANCHORS ©2023 DEWALT – REV. K

**Installation Specifications for Wood-Knocker II+ and Pan-Knocker II+ Push-In Thread Inserts<sup>1</sup>**

Insert Dimension / Property	Symbol	Units	Nominal Rod/Anchor Size	
			3/8"	1/2"
Outside diameter of steel insert body	$d_a$	in. (mm)	1.0 (25)	1.125 (29)
Insert head plate diameter	$d_{hp}$	in. (mm)	1.9 (48)	2.2 (56)
Plastic sleeve diameter	$d_s$	in. (mm)	2-3/8 (60)	2-3/8 (60)
Nominal embedment depth	$h_{nom}$	in. (mm)	1-7/8 (48)	2-3/16 (56)
Effective embedment depth	$h_{ef}$	in. (mm)	1.7 (43)	2.0 (56)
Minimum member thickness	$h_{min}$	in. (mm)	3-1/2 (89)	3-1/2 (89)
Minimum spacing distance	$s_{min}$	in. (mm)	$4d_a$	$4d_a$
Minimum edge distance	$c_{min}$	in. (mm)	$0.5d_{hp} + 3/4$ (19)	$0.5d_{hp} + 3/4$ (19)
Insert head plate thickness	$t_{hp}$	in. (mm)	3/16 (5)	3/16 (5)
UNC internal thread size	-	TPI	3/8-16	1/2-13
Approx. internal thread length	-	in.	5/8	11/16
Approx. gap between plastic sleeve opening and start of internal thread, after setting	-	in.	3/4	7/8

1. Inserts have internal thread size designations for coarse threads matching the nominal rod / anchor size.

**Wood-Knocker II+ and Pan-Knocker II+ Inserts Installed in Soffit of Form Pour Concrete Floor and Roof Members**

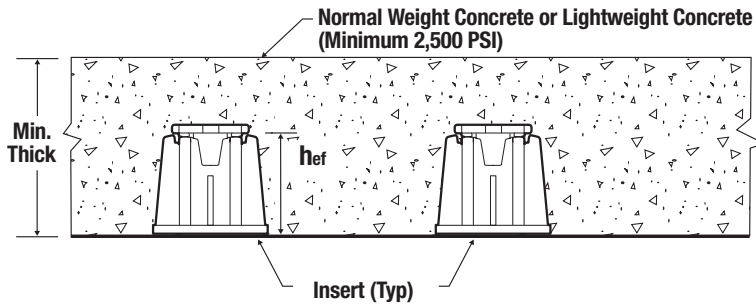

## PERFORMANCE DATA (ASD)

### Allowable Design Values for Inserts in Uncracked Concrete (lbs)<sup>1,2,3,4,5,6,7,8,9,10,11,12</sup>

Load Type	Wood-Knocker II+ and Pan-Knocker II+ Single Thread Inserts							Wood-Knocker II+ and Pan-Knocker II+ Push-In Thread Inserts	
	1/4" (LP)	3/8" (LP)	1/4"	3/8"	1/2"	5/8"	3/4"	3/8"	1/2"
Tension	1,085	1,085	1,055	1,800	1,800	1,800	1,800	1,725	2,200
Shear	400	1,085	720	1,710	1,800	1,800	1,800	1,470	2,200

Load Type	Wood-Knocker II+ and Pan-Knocker II+ Multi Thread Inserts													
	1/4 & 3/8 Multi (LP)		1/4 & 3/8 Multi		1/4 & 3/8 & 1/2 Multi			3/8 & 1/2 Multi		3/8 & 1/2 & 5/8 Multi			5/8 & 3/4 Multi	
	1/4"	3/8"	1/4"	3/8"	1/4"	3/8"	1/2"	3/8"	1/2"	3/8"	1/2"	5/8"	5/8"	3/4"
Tension	1,085	1,085	1,355	1,800	1,555	1,800	1,800	1,800	1,800	2,625	2,625	2,625	2,625	2,625
Shear	400	1,085	370	1,710	720	1,710	1,800	1,410	1,800	1,510	2,625	2,625	2,625	2,625

Allowable Stress Design Values in tables for inserts are provided for illustration and applicable only when the following design assumptions are followed:

- Concrete compressive strength,  $f'_c = 3,000$  psi given for normal weight concrete.
- Single anchors with static loads and with installation in accordance with published instructions.
- Concrete determined to remain uncracked for the life of the anchorage.
- Load combinations from AACI 318 (-19 and -14)-14 5.3 or ACI 318-11 9.2, as applicable (no seismic loading considered).
- 30% dead load and 70% live load, controlling load combination  $1.2D + 1.6L$ .
- Calculation of the weighted average for  $\alpha = 1.2 \cdot 0.3 + 1.6 \cdot 0.7 = 1.48$ .
- Assuming no edge distance influence ( $c_{a1} \geq 1.5h_{ef}$ ) and no side-face blowout in tension.
- Assuming no edge distance ( $c_{a1} \geq 3h_{ef}$ ) or corner distance influence ( $c_{a2} \geq 1.5c_{a1}$ ) in shear.
- Shear loads may be applied in any direction.
- $h \geq h_{min}$  according to ACI 318-19 17.9, ACI 318-14 17.7 or ACI 318-11 D.8, as applicable.
- Values are for Condition B where supplementary reinforcement in accordance with ACI 318-19 17.5.3, ACI 318-14 17.3.3 or ACI 318-11 D.4.3, as applicable, is not provided.
- The allowable loads shown in the table are for the inserts only. The design professional is responsible for checking threaded rod strength in tension, shear and combined tension and shear, as applicable. For designs that include combined tension and shear, the interaction of tension and shear loads must be calculated in accordance with ACI 318 (-19 and -14) Chapter 17 or ACI 318-11 Appendix D.

### Allowable Design Values for Inserts in Cracked Concrete (lbs)<sup>1,2,3,4,5,6,7,8,9,10,11,12</sup>

Load Type	Wood-Knocker II+ and Pan-Knocker II+ Single Thread Inserts							Wood-Knocker II+ and Pan-Knocker II+ Push-In Thread Inserts	
	1/4" (LP)	3/8" (LP)	1/4"	3/8"	1/2"	5/8"	3/4"	3/8"	1/2"
Tension	870	870	1,440	1,440	1,440	1,440	1,440	1,380	1,760
Shear	400	870	720	1,440	1,440	1,440	1,440	1,380	1,760

Load Type	Wood-Knocker II+ and Pan-Knocker II+ Multi Thread Inserts													
	1/4 & 3/8 Multi (LP)		1/4 & 3/8 Multi		1/4 & 3/8 & 1/2 Multi			3/8 & 1/2 Multi		3/8 & 1/2 & 5/8 Multi			5/8 & 3/4 Multi	
	1/4"	3/8"	1/4"	3/8"	1/4"	3/8"	1/2"	3/8"	1/2"	3/8"	1/2"	5/8"	5/8"	3/4"
Tension	870	870	1,355	1,440	1,440	1,440	1,440	1,440	1,440	2,100	2,100	2,100	2,100	2,100
Shear	400	870	370	1,440	720	1,440	1,440	1,440	1,440	1,510	2,100	2,100	2,100	2,100

Allowable Stress Design Values in tables for inserts are for illustration and applicable only when the following design assumptions are followed:

- Concrete compressive strength,  $f'_c = 3,000$  psi given for normal weight concrete.
- Single anchors with static loads and with installation in accordance with published instructions.
- Concrete determined to remain cracked for the life of the anchorage.
- Load combinations from ACI 318 (-19 and -14) 5.3 or ACI 318-11 9.2, as applicable (no seismic loading considered).
- 30% dead load and 70% live load, controlling load combination  $1.2D + 1.6L$ .
- Calculation of the weighted average for  $\alpha = 1.2 \cdot 0.3 + 1.6 \cdot 0.7 = 1.48$ .
- Assuming no edge distance influence ( $c_{a1} \geq 1.5h_{ef}$ ) and no side-face blowout in tension.
- Assuming no edge distance ( $c_{a1} \geq 3h_{ef}$ ) or corner distance influence ( $c_{a2} \geq 1.5c_{a1}$ ) in shear.
- Shear loads may be applied in any direction.
- $h \geq h_{min}$  according to ACI 318-19 17.9, ACI 318-14 17.7 or ACI 318-11 D.8, as applicable.
- Values are for Condition B where supplementary reinforcement in accordance with ACI 318-19 17.5.3, ACI 318-14 17.3.3 or ACI 318-11 D.4.3, as applicable, is not provided.
- The allowable loads shown in the table are for the inserts only. The design professional is responsible for checking threaded rod strength in tension, shear and combined tension and shear, as applicable. For designs that include combined tension and shear, the interaction of tension and shear loads must be calculated in accordance with ACI 318 (-19 and -14) Chapter 17 or ACI 318-11 Appendix D.

### UL Listings and FM Approvals for Supporting Fire Protection Services & Automatic Sprinkler Systems

Listing/Approval	Wood-Knocker II+ and Pan-Knocker II+ Single Thread Inserts							Wood-Knocker II+ and Pan-Knocker II+ Push-In Thread Inserts	
	1/4" LP	3/8" LP	1/4"	3/8"	1/2"	5/8"	3/4"	3/8"	1/2"
UL Max. Pipe Size	N/A	4"	N/A	4"	8"	8"	8"	4"	8"
FM Max. Pipe Size	N/A	4"	N/A	4"	8"	-	-	4"	8"

Listing/Approval	Wood-Knocker II+ and Pan-Knocker II+ Multi Thread Inserts													
	1/4 & 3/8 Multi (LP)		1/4 & 3/8 Multi		1/4 & 3/8 & 1/2 Multi			3/8 & 1/2 Multi		3/8 & 1/2 & 5/8 Multi			5/8 & 3/4 Multi	
	1/4"	3/8"	1/4"	3/8"	1/4"	3/8"	1/2"	3/8"	1/2"	3/8"	1/2"	5/8"	5/8"	3/4"
UL Max. Pipe Size	N/A	4"	N/A	4"	N/A	4"	8"	4"	8"	4"	8"	12"	12"	12"
FM Max. Pipe Size	N/A	4"	N/A	4"	N/A	4"	8"	4"	8"	4"	8"	12"	12"	12"

Underwriters Laboratories (UL Listed) – File No. EX1289 and VFXT7.EX1289. Also UL tested and recognized for use in air handling spaces (i.e. plenum rated locations).

FM Approvals (Factory Mutual) – see FM Approval Guide.

**STRENGTH DESIGN INFORMATION**

**Design Information For Wood Knocker II+ and Pan-Knocker II+ Single Thread Inserts<sup>1,2,3,4,5</sup>**



Design Information / Insert Property	Symbol	Units	1/4" (LP)	3/8" (LP)	1/4"	3/8"	1/2"	5/8"	3/4"
Outside diameter of the steel insert body	$d_a$	in. (mm)	0.5 (13)			0.7 (18)			1.0 (25)
Insert head net bearing area	$A_{brg}$	in <sup>2</sup> (mm <sup>2</sup> )	1.00 (645)			1.20 (762)			1.40 (903)
Effective embedment depth	$h_{ef}$	in. (mm)	1.25 (32)			1.75 (45)			1.75 (45)
<b>STEEL STRENGTH IN TENSION (ACI 318-19 17.6.1, ACI 318-14 17.4.1 or ACI 318-11 Section D.5.1)</b>									
Steel strength in tension of single insert	$N_{sa,insert}$	lb (kN)	3,545 (15.8)	6,535 (29.1)	3,545 (15.8)	9,005 (40.1)			12,685 (56.4)
Steel strength in tension of single insert, seismic	$N_{sa,insert,eq}$	lb (kN)	3,545 (15.8)	6,535 (29.1)	3,545 (15.8)	9,005 (40.1)			12,685 (56.4)
Reduction factor, steel strength in tension	$\phi$	-	0.65		0.65				0.65
<b>CONCRETE BREAKOUT STRENGTH IN TENSION (ACI 318-19 17.6.2, ACI 318-14 17.4.2 or ACI 318-11 D.5.2)</b>									
Effectiveness factor for cracked concrete	$k_c$	-	24 (for SI use a value of 10)						
Modification factor for uncracked concrete	$\Psi_{C,N}$	-	1.25						
Reduction factor, concrete strength in tension	$\phi$	-	0.70						
<b>STEEL STRENGTH IN SHEAR (ACI 318-19 17.7.1, ACI 318-14 17.5.1 or ACI 318-11 Section D.6.1)</b>									
Steel strength in shear of single insert	$V_{sa,insert,deck}$	lb (kN)	985 (4.4)	2,835 (12.6)	1,775 (7.9)	4,220 (18.8)	7,180 (31.9)		9,075 (40.4)
Steel strength in shear of single insert, seismic	$V_{sa,insert,eq,deck}$	lb (kN)	385 (1.7)	625 (2.8)	1,775 (7.9)	4,220 (18.8)	7,180 (31.9)		9,075 (40.4)
Reduction factor, steel strength in shear	$\phi$	-	0.60		0.60				0.60
<b>CONCRETE BREAKOUT STRENGTH IN SHEAR (ACI 318-19 17.7.2, ACI 318-14 17.5.2 or ACI 318-11 D.6.2) AND PRYOUT STRENGTH IN SHEAR (ACI 318-19 17.7.3, ACI 318-14 17.5.3 or ACI 318-11 D.6.3)</b>									
Load bearing length of insert	$l_e$	in. (mm)	1.25 (32)			1.75 (45)			1.75 (45)
Reduction factor, concrete strength in shear	$\phi$	-	0.70		0.70				0.70
Coefficient for pryout strength	$k_{cp}$	-	1		1				1
Reduction factor, pryout strength in shear	$\phi$	-	0.70		0.70				0.70
<ol style="list-style-type: none"> <li>Concrete must have a compressive strength <math>f'_c</math> of 2,500 psi minimum. Installation must comply with published instructions.</li> <li>Design of headed cast-in specialty inserts shall be in accordance with the provisions of ACI 318 (-19 and -14) Chapter 17 or ACI 318-11 Appendix D, as applicable, for cast-in headed anchors. Concrete breakout strength must also be in accordance with and steel deck figures, as applicable.</li> <li>Strength reduction factors for the inserts shall be taken from ACI 318-19 17.5.3, ACI 318-14 17.3.3 or ACI 318-11 D.4.3, as applicable, for cast-in headed anchors. Strength reduction factors for load combinations in accordance with ACI 318 (-19 and -14) 5.3 or ACI 318-11 9.2, as applicable, governed by steel strength of the insert are tabulated. Strength reduction values correspond to brittle steel elements. The value of <math>\phi</math> applies when the load combinations of 2021 IBC Section 1605.1 or 2018, 2015 and 2012 IBC 1605.2, ACI 318 (-19 or -14) Section 5.3 or ACI 318-11 9.2, as applicable, are used in accordance with ACI 318-14 17.3.3 or ACI 318-11 D.4.3, as applicable. If the load combinations of ACI 318-11 Appendix C are used, the appropriate value of <math>\phi</math> must be determined in accordance with ACI 318-11 D.4.4.</li> <li>Minimum spacing distance between anchors and minimum edge distances for cast-in headed anchors shall be in accordance with ACI 318-19 17.9, ACI 318-14 17.7 or ACI 318-11 D.8, as applicable and the installation tables for the inserts.</li> <li>The strengths shown in the table are for inserts only. Design professional is responsible for checking threaded rod strength in tension, shear, and combined tension and shear, as applicable. See steel design information for common threaded rod elements.</li> </ol>									

**Design Information for Wood Knocker II+ and Pan-Knocker II+ Multi Thread Inserts<sup>2,3,4,5</sup>**

Design Information	Symbol	Units	1/4 & 3/8 Multi (LP)		1/4 & 3/8 Multi		1/4 & 3/8 & 1/2 Multi			3/8 & 1/2 Multi			3/8 & 1/2 & 5/8 Multi			5/8 & 3/4 Multi	
			1/4"	3/8"	1/4"	3/8"	1/4"	3/8"	1/2"	3/8"	1/2"	3/8"	1/2"	5/8"	5/8"	3/4"	
Outside diameter of the steel insert body	$d_a$	in. (mm)	0.5 (13)		0.7 (18)							1.0 (25)					
Insert head net bearing area	$A_{brg}$	in <sup>2</sup> (mm <sup>2</sup> )	1.00 (645)		1.20 (762)							1.40 (903)					
Effective embedment depth	$h_{ef}$	in. (mm)	1.25 (32)		1.75 (45)							2.25 (57)					
<b>STEEL STRENGTH IN TENSION (ACI 318-19 17.6.1, ACI 318-14 17.4.1 or ACI 318-11 Section D.5.1)</b>																	
Steel strength in tension of single insert	$N_{sa,insert}$	lb (kN)	3,545 (15.8)	6,535 (29.1)	3,085 (13.7)	9,005 (40.1)	3,545 (18.1)	7,515 (33.4)	9,005 (40.1)	9,005 (40.1)	9,005 (40.1)	8,630 (38.4)	16,610 (73.9)	17,100 (76.1)			
Steel strength in tension of single insert, seismic	$N_{sa,insert,eq}$	lb (kN)	3,545 (15.8)	6,535 (29.1)	3,085 (13.7)	9,005 (40.1)	3,545 (18.1)	7,515 (33.4)	9,005 (40.1)	9,005 (40.1)	9,005 (40.1)	8,630 (38.4)	16,610 (73.9)	17,100 (76.1)			
Reduction factor, steel strength in tension	$\phi$	-	0.65		0.65							0.65					
<b>CONCRETE BREAKOUT STRENGTH IN TENSION (ACI 318-19 17.6.2, ACI 318-14 17.4.2 or ACI 318-11 D.5.2)</b>																	
Effectiveness factor for cracked concrete	$k_c$	-	24 (for SI use a value of 10)														
Modification factor for uncracked concrete	$\Psi_{c,N}$	-	1.25														
Reduction factor, concrete strength in tension	$\phi$	-	0.70														
<b>STEEL STRENGTH IN SHEAR (ACI 318-19 17.7.1, ACI 318-14 17.5.1 or ACI 318-11 Section D.6.1)</b>																	
Steel strength in shear of single insert	$V_{sa,insert,deck}$	lb (kN)	985 (4.4)	2,835 (12.6)	910 (4.1)	4,220 (18.8)	1,775 (7.9)	4,220 (18.8)	7,180 (31.9)	3,475 (15.5)	7,180 (31.9)	3,720 (16.2)	9,410 (41.9)	10,570 (47.0)	10,965 (48.8)		
Steel strength in shear of single insert, seismic	$V_{sa,insert,eq}$	lb (kN)	385 (1.7)	625 (2.8)	365 (1.6)	4,220 (18.8)	480 (2.1)	715 (3.2)	7,180 (31.9)	695 (3.1)	7,180 (31.9)	1,080 (4.8)	4,705 (20.9)	10,570 (47.0)	4,385 (19.1)	10,965 (48.8)	
Reduction factor, steel strength in shear	$\phi$	-	0.60		0.60							0.60					
<b>CONCRETE BREAKOUT STRENGTH IN SHEAR (ACI 318-19 17.7.2, ACI 318-14 17.5.2 or ACI 318-11 D.6.2) AND PRYOUT STRENGTH IN SHEAR (ACI 318-19 17.7.3, ACI 318-14 17.5.3 or ACI 318-11 D.6.3)</b>																	
Load bearing length of insert	$l_e$	in. (mm)	1.25 (32)		1.75 (45)							2.25 (57)					
Reduction factor, concrete strength in shear	$\phi$	-	0.70		0.70							0.70					
Coefficient for prout strength	$k_{cp}$	-	1		1							1					
Reduction factor, prout strength in shear	$\phi$	-	0.70		0.70							0.70					
<ol style="list-style-type: none"> <li>Concrete must have a compressive strength <math>f'_c</math> of 2,500 psi minimum. Installation must comply with published instructions.</li> <li>Design of headed cast-in specialty inserts shall be in accordance with the provisions of ACI 318 (-19 and -14) Chapter 17 or ACI 318-11 Appendix D, as applicable, for cast-in headed anchors. Concrete breakout strength must also be in accordance with and steel deck figures, as applicable.</li> <li>Strength reduction factors for the inserts shall be taken from ACI 318-19 17.5.3, ACI 318-14 17.3.3 or ACI 318-11 D.4.3, as applicable, for cast-in headed anchors. Strength reduction factors for load combinations in accordance with ACI 318 (-19 and -14) 5.3 or ACI 318-11 9.2, as applicable, governed by steel strength of the insert are tabulated. Strength reduction values correspond to brittle steel elements. The value of <math>\phi</math> applies when the load combinations of 2021 IBC Section 1605.1 or 2018, 2015 and 2012 IBC 1605.2, ACI 318 (-19 or -14) Section 5.3 or ACI 318-11 9.2, as applicable, are used in accordance with ACI 318-14 17.3.3 or ACI 318-11 D.4.3, as applicable. If the load combinations of ACI 318-11 Appendix C are used, the appropriate value of <math>\phi</math> must be determined in accordance with ACI 318-11 D.4.4.</li> <li>Minimum spacing distance between anchors and minimum edge distances for cast-in headed anchors shall be in accordance with ACI 318-19 17.9, ACI 318-14 17.7 or ACI 318-11 D.8, as applicable and the installation tables for the inserts.</li> <li>The strengths shown in the table are for inserts only. Design professional is responsible for checking threaded rod strength in tension, shear, and combined tension and shear, as applicable. See steel design information for common threaded rod elements.</li> </ol>																	

**Design Information for Wood-Knocker II+ and Pan-Knocker II+ Push-In Thread Inserts<sup>1,2,3,4,5</sup>**

Design Information	Symbol	Units	3/8"	1/2"
Outside diameter of the steel insert body	$d_a$	in. (mm)	1.0 (25)	1.125 (29)
Insert head plate net bearing area	$A_{brg}$	in <sup>2</sup> (mm <sup>2</sup> )	2.0 (1290)	2.7 (1742)
Effective embedment depth	$h_{ef}$	in. (mm)	1.7 (43)	2.0 (51)
<b>STEEL STRENGTH IN TENSION (ACI 318-19 17.6.1, ACI 318-14 17.4.1 or ACI 318-11 Section D.5.1)</b>				
Steel strength in tension of single insert	$N_{sa,insert}$	lb (kN)	11,265 (50.1)	17,595 (78.3)
Steel strength in tension of single insert, seismic	$N_{sa,insert,eq}$	lb (kN)	11,265 (50.1)	17,595 (7.3)
Reduction factor, steel strength in tension	$\phi$	-	0.65	
<b>CONCRETE BREAKOUT STRENGTH IN TENSION (ACI 318-19 17.6.2, ACI 318-14 17.4.2 or ACI 318-11 D.5.2)</b>				
Effectiveness factor for cracked concrete	$k_c$	-	24 (for SI use a value of 10)	
Modification factor for uncracked concrete	$\Psi_{c,N}$	-	1.25	
Reduction factor, concrete strength in tension	$\phi$	-	0.70	
<b>STEEL STRENGTH IN SHEAR (ACI 318-19 17.7.1, ACI 318-14 17.5.1 or ACI 318-11 Section D.6.1)</b>				
Steel strength in shear of single insert	$V_{sa,insert,deck}$	lb (kN)	3,625 (16.1)	5,955 (26.5)
Steel strength in shear of single insert, seismic	$V_{sa,insert,eq}$	lb (kN)	3,625 (16.1)	5,955 (26.5)
Reduction factor, steel strength in shear	$\phi$	-	0.60	
<b>CONCRETE BREAKOUT STRENGTH IN SHEAR (ACI 318-19 17.7.2, ACI 318-14 17.5.2 or ACI 318-11 D.6.2) AND PRYOUT STRENGTH IN SHEAR (ACI 318-19 17.7.3, ACI 318-14 17.5.3 or ACI 318-11 D.6.3)</b>				
Load bearing length of insert	$l_e$	in. (mm)	1.7 (43)	2.0 (51)
Reduction factor, concrete strength in shear	$\phi$	-	0.70	
Coefficient for pryout strength	$k_{cp}$	-	1	
Reduction factor, pryout strength in shear	$\phi$	-	0.70	
<ol style="list-style-type: none"> <li>Concrete must have a compressive strength <math>f'_c</math> of 2,500 psi minimum. Installation must comply with published instructions.</li> <li>Design of headed cast-in specialty inserts shall be in accordance with the provisions of ACI 318 (-19 and -14) Chapter 17 or ACI 318-11 Appendix D, as applicable, for cast-in headed anchors. Concrete breakout strength must also be in accordance with and steel deck figures, as applicable.</li> <li>Strength reduction factors for the inserts shall be taken from ACI 318-19 17.5.3, ACI 318-14 17.3.3 or ACI 318-11 D.4.3, as applicable, for cast-in headed anchors. Strength reduction factors for load combinations in accordance with ACI 318 (-19 and -14) 5.3 or ACI 318-11 9.2, as applicable, governed by steel strength of the insert are tabulated. Strength reduction values correspond to brittle steel elements. The value of <math>\phi</math> applies when the load combinations of 2021 IBC Section 1605.1 or 2018, 2015 and 2012 IBC 1605.2, ACI 318 (-19 or -14) Section 5.3 or ACI 318-11 9.2, as applicable, are used in accordance with ACI 318-19 17.5.3, ACI 318-14 17.3.3 or ACI 318-11 D.4.3, as applicable. If the load combinations of ACI 318-11 Appendix C are used, the appropriate value of <math>\phi</math> must be determined in accordance with ACI 318-11 D.4.4.</li> <li>Minimum spacing distance between anchors and minimum edge distances for cast-in headed anchors shall be in accordance with ACI 318-19 17.9, ACI 318-14 17.7 or ACI 318-11 D.8, as applicable and the installation tables for the inserts.</li> <li>The strengths shown in the table are for inserts only. Design professional is responsible for checking threaded rod strength in tension, shear, and combined tension and shear, as applicable. See steel design information for common threaded rod elements.</li> </ol>				



**Specifications And Physical Properties Of Common Carbon Steel Threaded Rod Elements<sup>1</sup>**

Threaded Rod Specification		Units	Min. Specified Ultimate Strength, $F_{uta}$	Min. Specified Yield Strength 0.2 Percent Offset, $F_{ya}$	$F_{uta}$ — $F_{ya}$	Elongation Minimum Percent <sup>4</sup>	Reduction Of Area Min. Percent	Related Nut Specification <sup>5</sup>
Carbon Steel	ASTM A36/A36M or ASTM F1554 Grade 36	psi (MPa)	58,000 (400)	36,000 (248)	1.61	23	40 (50 for A36)	ASTM A563 Gr. A or A194 Grade 2
	ASTM A193/A193M <sup>3</sup> Grade B7	psi (MPa)	125,000 (860)	105,000 (720)	1.19	16	50	ASTM A563 Gr. A or A194 Grade 2

For SI: 1 inch = 25.4 mm, 1 psi = 0.006897 MPa. For pound-inch units: 1 mm = 0.03937 inch, 1 MPa = 145.0 psi.

1. Inserts may be used in conjunction with all grades of continuously threaded carbon steels (all-thread) that comply with code reference standards and that have thread characteristics comparable with ANSI B1.1 UNC Coarse Thread Series.
2. Standard Specification for Carbon Structural Steel.
3. Standard Specification for Alloy-Steel and Stainless Steel Bolting Materials for High Temperature or High Pressure Service and Other Special Purpose Applications.
4. Based on 2-inch (50 mm) gauge length except for ASTM A36/A36M and ASTM A193, which are based on a gauge length of 4d ( $d_{rod}$ ).
5. Where nuts are applicable, nuts of other grades and style having specified proof load stress greater than the specified grade and style are also suitable.



**Steel Design Information For Common Threaded Rod Elements Used With Concrete Inserts<sup>1,2,3,4</sup>**

Design Information		Symbol	Units	1/4-inch	3/8-inch	1/2-inch	5/8-inch	3/4-inch
Threaded rod nominal outside diameter		$d_{rod}$	in. (mm)	0.250 (6.4)	0.375 (9.5)	0.500 (12.7)	0.625 (15.9)	0.750 (19.1)
Threaded rod effective cross-sectional area		$A_{se}$	in <sup>2</sup> (mm <sup>2</sup> )	0.032 (21)	0.078 (50)	0.142 (92)	0.226 (146)	0.335 (216)
Steel strength in tension of threaded rod	ASTM A36 or F1554, Grade 36	$N_{sa,rod,A36}$	lb (kN)	1,855 (8.2)	4,525 (20.0)	8,235 (36.6)	13,110 (58.3)	19,430 (86.3)
Steel strength in tension of threaded rod, seismic		$N_{sa,rod,eq,A36}$	lb (kN)	1,855 (8.2)	4,525 (20.0)	8,235 (36.6)	13,110 (58.3)	19,430 (86.4)
Steel strength in tension of threaded rod	ASTM A193, Gr. B7	$N_{sa,rod,B7}$	lb (kN)	4,000 (17.7)	9,750 (43.1)	17,750 (78.9)	28,250 (125.7)	41,875 (186.0)
Steel strength in tension of threaded rod, seismic		$N_{sa,rod,eq,B7}$	lb (kN)	4,000 (17.7)	9,750 (43.1)	17,750 (78.9)	28,250 (125.7)	41,875 (186.0)
Reduction factor, steel strength in tension		$\phi$	-	0.75				
Steel strength in shear of threaded	ASTM A36 or F1554, Grade 36	$V_{sa,rod,A36}$	lb (kN)	1,115 (4.9)	2,715 (12.1)	4,940 (22.0)	7,865 (35.0)	11,660 (51.9)
Steel strength in shear of threaded rod, seismic		$V_{sa,rod,eq,A36}$	lb (kN)	780 (3.5)	1,900 (8.4)	3,460 (15.4)	5,505 (24.5)	8,160 (36.3)
Steel strength in shear of threaded rod	ASTM A193, Gr. B7	$V_{sa,rod,B7}$	lb (kN)	2,385 (10.6)	5,815 (25.9)	10,640 (47.3)	16,950 (75.4)	25,085 (111.6)
Steel strength in shear of threaded rod, seismic		$V_{sa,rod,eq,B7}$	lb (kN)	1,680 (7.5)	4,095 (18.2)	7,455 (33.2)	11,865 (52.8)	17,590 (78.2)
Reduction factor, steel strength in shear		$\phi$	-	0.65				

For SI: 1 inch = 25.4 mm, 1 pound = 0.00445 kN, 1 in<sup>2</sup> = 645.2 mm<sup>2</sup>. For pound-inch unit: 1 mm = 0.03937 inches.

1. Values provided for steel element material types based on minimum specified strengths and calculated in accordance with ACI 318-11 Eq. (D-2) and Eq. (D-29).
2.  $\phi N_{sa}$  shall be the lower of the  $\phi N_{sa,rod}$  or  $\phi N_{sa,insert}$  for static steel strength in tension; for seismic loading  $\phi N_{sa,eq}$  shall be the lower of the  $\phi N_{sa,rod,eq}$  or  $\phi N_{sa,insert,eq}$ .
3.  $\phi V_{sa}$  shall be the lower of the  $\phi V_{sa,rod}$  or  $\phi V_{sa,insert}$  for static steel strength in tension; for seismic loading  $\phi V_{sa,eq}$  shall be the lower of the  $\phi V_{sa,rod,eq}$  or  $\phi V_{sa,insert,eq}$ .
4. Strength reduction factors shall be taken from ACI 318-19 17.5.3, ACI 318-14 17.3.3 or ACI 318-11 D.4.3 for steel elements. Condition B is assumed. Strength reduction factors for load combinations in accordance with ACI 318 (-19 and -14) Section 5.3 or ACI 318-11 Section 9.2 governed by steel strength of the threaded rod are taken as 0.75 for tension and 0.65 for shear; values correspond to ductile steel elements. The value of  $\phi$  applies when the load combinations of 2021 IBC Section 1605.1 or 2018, 2015 and 2012 IBC 1605.2, ACI 318 (-19 or -14) Section 5.3 or ACI 318-11 Section 9.2 are used in accordance with ACI 318-19 17.5.3, ACI 318-14 17.3.3 or ACI 318-11 D.4.3. If the load combinations of ACI 318-11 Appendix C are used, then the appropriate value of  $\phi$  must be determined in accordance with ACI 318-11 D4.4.

**DESIGN STRENGTH TABLES (SD)**

**Tension and Shear Design Strengths for Wood-Knocker II+ and Pan-Knocker II+ Single Thread Inserts Installed in Form Poured Concrete and Roof Members - Uncracked Concrete<sup>1,2,3,4,5,6,7</sup>**



Nominal Anchor Diameter (in.)	Embed. Depth $h_{ef}$ (in.)	Minimum Concrete Compressive Strength					
		$f'c = 3,000$ psi		$f'c = 4,000$ psi		$f'c = 6,000$ psi	
		$\phi N_n$ Tension (lbs.)	$\phi V_n$ Shear (lbs.)	$\phi N_n$ Tension (lbs.)	$\phi V_n$ Shear (lbs.)	$\phi N_n$ Tension (lbs.)	$\phi V_n$ Shear (lbs.)
1/4" (LP)	1-1/4	1,605	590	1,855	590	2,275	590
3/8" (LP)	1-1/4	1,605	1,235	1,855	1,425	2,275	1,700
1/4"	1-3/4	2,665	2,420	3,075	2,795	3,765	3,425
3/8"	1-3/4	2,665	2,420	3,075	2,795	3,765	3,425
1/2"	1-3/4	2,665	2,420	3,075	2,795	3,765	3,425
5/8"	1-3/4	2,665	2,665	3,075	3,075	3,765	3,765
3/4"	1-3/4	2,665	2,665	3,075	3,075	3,765	3,765

■ - Anchor Pullout/Pryout Strength Controls 
 ■ - Concrete Breakout Strength Controls 
 ■ - Steel Strength Controls

**Tension and Shear Design Strengths for Wood-Knocker II+ and Pan-Knocker II+ Single Thread Inserts Installed in Form Poured Concrete and Roof Members - Cracked Concrete<sup>1,2,3,4,5,6,7,8</sup>**



Nominal Anchor Diameter (in.)	Embed. Depth $h_{ef}$ (in.)	Minimum Concrete Compressive Strength					
		$f'c = 3,000$ psi		$f'c = 4,000$ psi		$f'c = 6,000$ psi	
		$\phi N_n$ Tension (lbs.)	$\phi V_n$ Shear (lbs.)	$\phi N_n$ Tension (lbs.)	$\phi V_n$ Shear (lbs.)	$\phi N_n$ Tension (lbs.)	$\phi V_n$ Shear (lbs.)
1/4" (LP)	1-1/4	1,285	590	1,485	590	1,820	590
3/8" (LP)	1-1/4	1,285	885	1,485	1,020	1,820	1,250
1/4"	1-3/4	2,130	1,730	2,460	2,000	3,015	2,445
3/8"	1-3/4	2,130	1,730	2,460	2,000	3,015	2,445
1/2"	1-3/4	2,130	1,730	2,460	2,000	3,015	2,445
5/8"	1-3/4	2,130	2,130	2,460	2,460	3,015	3,015
3/4"	1-3/4	2,130	2,130	2,460	2,460	3,015	3,015

■ - Anchor Pullout/Pryout Strength Controls 
 ■ - Concrete Breakout Strength Controls 
 ■ - Steel Strength Controls

- Tabular values are provided for illustration and are applicable for single anchors installed in normal-weight concrete with minimum slab thickness,  $h_a = h_{min}$ , and with the following conditions:
  - No edge distance influence ( $C_{a1} \geq 1.5h_{ef}$ ) and no side-face blowout in tension.
  - No edge distance ( $C_{a1} \geq 3h_{ef}$ ) or corner distance influence ( $C_{a2} \geq 1.5C_{a1}$ ) in shear.
- Calculations were performed following methodology in ACI 318-19 17.5.3, ACI 318 (-19 and -14) Chapter 17 or ACI 318-11 Appendix D. The load level corresponding to the failure mode listed (steel strength of insert ( $N_{sa,insert}$ ,  $V_{sa,insert}$ ), concrete breakout strength, or pryout strength) must be checked against the tabulated steel strength of the corresponding threaded rod type, ( $N_{sa,rod}$ ,  $V_{sa,rod}$ ), the lowest load level controls.
- Strength reduction factors shall be taken from ACI 318-14 17.3.3 or ACI 318-11 D.4.3 for cast-in headed anchors. Condition B is assumed. Strength reduction factors for load combinations in accordance with ACI 318 (-19 and -14) Section 5.3 or ACI 318-11 Section 9.2 governed by steel strength of the insert are taken as 0.65 for tension and 0.60 for shear; values correspond to brittle steel elements.
- Tabular values are permitted for static loads only, seismic loading is not considered with these tables.
- For designs that include combined tension and shear, the interaction of tension and shear loads must be calculated in accordance with ACI 318 (-19 and -14) Chapter 17 or ACI 318-11 Appendix D.
- Interpolation is not permitted to be used with the tabular values. For intermediate base material compressive strengths please see ACI 318 (-19 and -14) Chapter 17 or ACI 318-11 Appendix D and information contained in this product supplement. For other design conditions including seismic considerations please see ACI 318 (-19 and -14) Chapter 17 or ACI 318-11 Appendix D.
- For lightweight concrete, where concrete breakout or anchor pullout/pryout strength controls, the tabulated values must be multiplied by 0.85 for sand-lightweight and 0.75 for all-lightweight, as applicable.
- For seismic design in accordance with ACI 318, the tabulated tension design strengths for concrete breakout and pullout must be multiplied by a factor of 0.75.

**MECHANICAL ANCHORS**

**WOOD-KNOCKER® II+/PAN-KNOCKER™ II+**  
Concrete Inserts

**Tension and Shear Design Strengths for Wood-Knocker II+ and Pan-Knocker II+ Multi Thread Inserts Installed in Form Poured Concrete and Roof Members - Uncracked Concrete**<sup>1,2,3,4,5,6,7</sup>



Nominal Anchor Diameter (in.)	Embed. Depth $h_{ef}$ (in.)	Minimum Concrete Compressive Strength					
		f'c = 3,000 psi		f'c = 4,000 psi		f'c = 6,000 psi	
		$\phi N_n$ Tension (lbs.)	$\phi V_n$ Shear (lbs.)	$\phi N_n$ Tension (lbs.)	$\phi V_n$ Shear (lbs.)	$\phi N_n$ Tension (lbs.)	$\phi V_n$ Shear (lbs.)
1/4" (1/4 - 3/8" Multi LP)	1-1/4	1,605	590	1,855	590	2,275	590
3/8" (1/4 - 3/8" Multi LP)	1-1/4	1,605	1,235	1,855	1,425	2,275	1,700
1/4" (1/4 - 3/8" Multi)	1-3/4	2,005	545	2,005	545	2,005	545
3/8" (1/4 - 3/8" Multi)	1-3/4	2,665	2,420	3,075	2,530	3,765	2,530
1/4" (1/4 - 3/8 - 1/2" Multi)	1-3/4	2,305	1,065	2,305	1,065	2,305	1,065
3/8" (1/4 - 3/8 - 1/2" Multi)	1-3/4	2,665	2,420	3,075	2,530	3,765	2,530
1/2" (1/4 - 3/8 - 1/2" Multi)	1-3/4	2,665	2,420	3,075	2,795	3,765	3,425
3/8" (3/8 - 1/2" Multi)	1-3/4	2,665	2,085	3,075	2,085	3,765	2,085
1/2" (3/8 - 1/2" Multi)	1-3/4	2,665	2,420	3,075	2,795	3,765	3,425
3/8" (3/8 - 1/2 - 5/8" Multi)	2-1/4	3,880	2,230	4,485	2,230	5,490	2,230
1/2" (3/8 - 1/2 - 5/8" Multi)	2-1/4	3,880	3,880	4,485	4,485	5,490	5,490
5/8" (3/8 - 1/2 - 5/8" Multi)	2-1/4	3,880	3,880	4,485	4,485	5,490	5,490
5/8" (5/8 - 3/4" Multi)	2-1/4	3,880	3,880	4,485	4,485	5,490	5,490
3/4" (5/8 - 3/4" Multi)	2-1/4	3,880	3,880	4,485	4,485	5,490	5,490

■ - Anchor Pullout/Pryout Strength Controls 
 ■ - Concrete Breakout Strength Controls 
 ■ - Steel Strength Controls

**Tension and Shear Design Strengths for Wood-Knocker II+ and Pan-Knocker II+ Multi Thread Inserts Installed in Form Poured Concrete and Roof Members - Cracked Concrete**<sup>1,2,3,4,5,6,7,8</sup>



Nominal Anchor Diameter (in.)	Embed. Depth $h_{ef}$ (in.)	Minimum Concrete Compressive Strength					
		f'c = 3,000 psi		f'c = 4,000 psi		f'c = 6,000 psi	
		$\phi N_n$ Tension (lbs.)	$\phi V_n$ Shear (lbs.)	$\phi N_n$ Tension (lbs.)	$\phi V_n$ Shear (lbs.)	$\phi N_n$ Tension (lbs.)	$\phi V_n$ Shear (lbs.)
1/4" (1/4 - 3/8" Multi LP)	1-1/4	1,285	590	1,485	590	1,820	590
3/8" (1/4 - 3/8" Multi LP)	1-1/4	1,285	885	1,485	1,020	1,820	1,250
1/4" (1/4 - 3/8" Multi)	1-3/4	2,005	545	2,005	545	2,005	545
3/8" (1/4 - 3/8" Multi)	1-3/4	2,130	1,730	2,460	2,000	3,015	2,445
1/4" (1/4 - 3/8 - 1/2" Multi)	1-3/4	2,130	1,065	2,305	1,065	2,305	1,065
3/8" (1/4 - 3/8 - 1/2" Multi)	1-3/4	2,130	1,730	2,460	2,000	3,015	2,445
1/2" (1/4 - 3/8 - 1/2" Multi)	1-3/4	2,130	1,730	2,460	2,000	3,015	2,445
3/8" (3/8 - 1/2" Multi)	1-3/4	2,130	1,730	2,460	2,000	3,015	2,085
1/2" (3/8 - 1/2" Multi)	1-3/4	2,130	1,730	2,460	2,000	3,015	2,445
3/8" (3/8 - 1/2 - 5/8" Multi)	2-1/4	3,105	2,230	3,585	2,230	4,390	2,230
1/2" (3/8 - 1/2 - 5/8" Multi)	2-1/4	3,105	2,895	3,585	3,340	4,390	4,090
5/8" (3/8 - 1/2 - 5/8" Multi)	2-1/4	3,105	2,895	3,585	3,340	4,390	4,090
5/8" (5/8 - 3/4" Multi)	2-1/4	3,105	2,895	3,585	3,340	4,390	4,090
3/4" (5/8 - 3/4" Multi)	2-1/4	3,105	2,895	3,585	3,340	4,390	4,090

■ - Anchor Pullout/Pryout Strength Controls 
 ■ - Concrete Breakout Strength Controls 
 ■ - Steel Strength Controls

- Tabular values are provided for illustration and are applicable for single anchors installed in normal-weight concrete with minimum slab thickness,  $h_a = h_{min}$ , and with the following conditions:
  - No edge distance influence ( $C_{a1} \geq 1.5h_{ef}$ ) and no side-face blowout in tension.
  - No edge distance ( $C_{a1} \geq 3h_{ef}$ ) or corner distance influence ( $C_{a2} \geq 1.5C_{a1}$ ) in shear.
- Calculations were performed following methodology in ACI 318 (-19 and -14) Chapter 17 or ACI 318-11 Appendix D. The load level corresponding to the failure mode listed [steel strength of insert ( $N_{sa,insert}$ ), concrete breakout strength, or pryout strength] must be checked against the tabulated steel strength of the corresponding threaded rod type, ( $N_{sa,rod}$ ,  $V_{sa,rod}$ ), the lowest load level controls.
- Strength reduction factors shall be taken from ACI 318-19 17.5.3, ACI 318-14 17.3.3 or ACI 318-11 D.4.3 for cast-in headed anchors. Condition B is assumed. Strength reduction factors for load combinations in accordance with ACI 318 (-19 and -14) Section 5.3 or ACI 318-11 Section 9.2 governed by steel strength of the insert are taken as 0.65 for tension and 0.60 for shear; values correspond to brittle steel elements.
- Tabular values are permitted for static loads only, seismic loading is not considered with these tables.
- For designs that include combined tension and shear, the interaction of tension and shear loads must be calculated in accordance with ACI 318 (-19 and -14) Chapter 17 or ACI 318-11 Appendix D.
- Interpolation is not permitted to be used with the tabular values. For intermediate base material compressive strengths please see ACI 318 (-19 and -14) Chapter 17 or ACI 318-11 Appendix D and information contained in this product supplement. For other design conditions including seismic considerations please see ACI 318 (-19 and -14) Chapter 17 or ACI 318-11 Appendix D.
- For lightweight concrete, where concrete breakout or anchor pullout/pryout strength controls, the tabulated values must be multiplied by 0.85 for sand-lightweight and 0.75 for all-lightweight, as applicable.
- For seismic design in accordance with ACI 318, the tabulated tension design strengths for concrete breakout and pullout must be multiplied by a factor of 0.75.



**Tension and Shear Design Strengths for Wood-Knocker II+ and Pan-Knocker II+ Push-In Thread Inserts Installed in Form Poured Concrete and Roof Members - Uncracked Concrete**<sup>1,2,3,4,5,6,7</sup>

Nominal Anchor Diameter (in.)	Embed. Depth $h_{ef}$ (in.)	Minimum Concrete Compressive Strength					
		$f'_c = 3,000$ psi		$f'_c = 4,000$ psi		$f'_c = 6,000$ psi	
		$\phi N_n$ Tension (lbs.)	$\phi V_n$ Shear (lbs.)	$\phi N_n$ Tension (lbs.)	$\phi V_n$ Shear (lbs.)	$\phi N_n$ Tension (lbs.)	$\phi V_n$ Shear (lbs.)
3/8" Push-In	1.70	2,550	2,175	2,945	2,175	3,605	2,175
1/2" Push-In	2.00	3,255	3,255	3,755	3,575	4,600	3,575

■ - Anchor Pullout/Pryout Strength Controls 
 ■ - Concrete Breakout Strength Controls 
 ■ - Steel Strength Controls



**Tension and Shear Design Strengths for Wood-Knocker II+ and Pan-Knocker II+ Push-In Thread Inserts Installed in Form Poured Concrete and Roof Members - Cracked Concrete**<sup>1,2,3,4,5,6,7,8</sup>

Nominal Anchor Diameter (in.)	Embed. Depth $h_{ef}$ (in.)	Minimum Concrete Compressive Strength					
		$f'_c = 3,000$ psi		$f'_c = 4,000$ psi		$f'_c = 6,000$ psi	
		$\phi N_n$ Tension (lbs.)	$\phi V_n$ Shear (lbs.)	$\phi N_n$ Tension (lbs.)	$\phi V_n$ Shear (lbs.)	$\phi N_n$ Tension (lbs.)	$\phi V_n$ Shear (lbs.)
3/8" Push-In	1.70	2,040	2,040	2,355	2,175	2,885	2,175
1/2" Push-In	2.00	2,605	2,605	3,005	3,005	3,680	3,575

■ - Anchor Pullout/Pryout Strength Controls 
 ■ - Concrete Breakout Strength Controls 
 ■ - Steel Strength Controls

- Tabular values are provided for illustration and are applicable for single anchors installed in normal-weight concrete with minimum slab thickness,  $h_a = h_{min}$ , and with the following conditions:
  - No edge distance influence ( $C_{a1} \geq 1.5h_a$ ) and no side-face blowout in tension.
  - No edge distance ( $C_{a1} \geq 3h_a$ ) or corner distance influence ( $C_{a2} \geq 1.5C_{a1}$ ) in shear.
- Calculations were performed following methodology in ACI 318 (-19 and -14) Chapter 17 or ACI 318-11 Appendix D. The load level corresponding to the failure mode listed [steel strength of insert ( $N_{sa,insert}$ ,  $V_{sa,insert}$ ), concrete breakout strength, or pryout strength] must be checked against the tabulated steel strength of the corresponding threaded rod type, ( $N_{sa,rod}$ ,  $V_{sa,rod}$ ), the lowest load level controls.
- Strength reduction factors shall be taken from ACI 318-19 17.5.3, ACI 318-14 17.3.3 or ACI 318-11 D.4.3 for cast-in headed anchors. Condition B is assumed. Strength reduction factors for load combinations in accordance with ACI 318 (-19 and -14) Section 5.3 or ACI 318-11 Section 9.2 governed by steel strength of the insert are taken as 0.65 for tension and 0.60 for shear; values correspond to brittle steel elements.
- Tabular values are permitted for short-term static loads only, seismic loading is not considered with these tables.
- For designs that include combined tension and shear, the interaction of tension and shear loads must be calculated in accordance with ACI 318 (-19 and -14) Chapter 17 or ACI 318-11 Appendix D.
- Interpolation is not permitted to be used with the tabular values. For intermediate base material compressive strengths please see ACI 318 (-19 and -14) Chapter 17 or ACI 318-11 Appendix D and information contained in this product supplement. For other design conditions including seismic considerations please see ACI 318 (-19 and -14) Chapter 17 or ACI 318-11 Appendix D.
- For lightweight concrete, where concrete breakout or anchor pullout/pryout strength controls, the tabulated values must be multiplied by 0.85 for sand-lightweight and 0.75 for all-lightweight, as applicable.
- For seismic design in accordance with ACI 318, the tabulated tension design strengths for concrete breakout and pullout must be multiplied by a factor of 0.75.



**Tension and Shear Design Strength of Steel Elements (Steel Strength)**<sup>1,2,3,4</sup>

Nominal Rod Diameter (in.)	Steel Elements - Threaded Rod			
	ASTM A36		ASTM A193 Grade B7	
	$\phi N_{sa,rod}$ Tension (lbs.)	$\phi V_{sa,rod}$ Shear (lbs.)	$\phi N_{sa,rod}$ Tension (lbs.)	$\phi V_{sa,rod}$ Shear (lbs.)
1/4	1,390	720	3,000	1,550
3/8	3,395	1,750	7,315	3,780
1/2	6,175	3,210	13,315	6,915
5/8	9,835	5,115	21,190	11,020
3/4	14,550	7,565	31,405	16,305

■ - Steel Strength Controls

- Steel tensile design strength according to ACI 318 Appendix D and ACI 318 Chapter 17,  $\phi N_{sa} = \phi \cdot A_{se,N} \cdot f_{uta}$
- The tabulated steel design strength in tension for the threaded rod must be checked against the design strength of the steel insert, concrete breakout and pullout design strength to determine the controlling failure mode, the lowest load level controls.
- Steel shear design strength according to ACI 318 Appendix D and ACI 318 Chapter 17,  $\phi V_{sa} = \phi \cdot 0.60 \cdot A_{se,N} \cdot f_{uta}$
- The tabulated steel design strength in shear for the threaded rod must be checked against the design strength of the steel insert, concrete breakout and pryout design strength to determine the controlling failure mode, the lowest load level controls.

**ORDERING INFORMATION**

**Wood-Knocker® II+ Form Insert (UNC internal thread)**

Cat. No.	Description	Color Code	Pack Qty.
PFM2500014	1/4" Wood-Knocker II+ LP (Low Profile)	Brown	100
PFM2500038	3/8" Wood-Knocker II+ LP (Low Profile)	Green	100
PFM2521100	1/4" Wood-Knocker II+	Brown	100
PFM2521150	3/8" Wood-Knocker II+	Green	100
PFM2521200	1/2" Wood-Knocker II+	Yellow	100
PFM2521250	5/8" Wood-Knocker II+	Red	100
PFM2521300	3/4" Wood-Knocker II+	Purple	100
PFM2501438	1/4-3/8" Wood-Knocker II+ Multi LP (Low Profile)	White	100
PFM2521438	1/4-3/8" Wood-Knocker II+ Multi	White	100
PFM2521350	3/8-1/2" Wood-Knocker II+ Multi	Gray	100
PFM253143812	1/4-3/8-1/2" Wood-Knocker II+ Multi	Aqua	100
PFM253381258	3/8-1/2-5/8" Wood-Knocker II+ Multi	Orange	50
PFM2525834	5/8-3/4" Wood-Knocker II+ Multi	Black	50
PFM2610038	3/8" Wood-Knocker II+ Push-In Thread	Green	50
PFM2610012	1/2" Wood-Knocker II+ Push-In Thread	Yellow	50

Inserts are color coded to easily identify location, type and sizes of the internal diameters.



**Wood-Knocker II+ Installation Accessories and Tools**

Cat. No.	Description	Pack Qty.
PFM3612000	Wood-Knocker II+ Installation Tool	1
DWHT51439	16oz Steel Curve Claw Hammer	1

The Wood-Knocker II+ installation tool features a magnetic end to help hold the insert and assist in placement.



**Pan-Knocker II+ Form Insert (UNC internal thread)**

Cat. No.	Description	Color Code	Pack Qty.
PFM2501438NN	1/4-3/8" Pan-Knocker II+ Multi LP (Low Profile)	White	100
PFM253143812NN	1/4-3/8-1/2" Pan-Knocker II+ Multi	Aqua	100
PFM253381258NN	3/8-1/2-5/8" Pan-Knocker II+ Multi	Orange	100
PFM2525834NN	5/8-3/4" Pan-Knocker II+ Multi	Black	100
PFM2610038NN	3/8" Pan-Knocker II+ Push-In Thread	Green	50
PFM2610012NN	1/2" Pan-Knocker II+ Push-In Thread	Yellow	50

Pan-Knocker II+ form inserts must be mounted (e.g. screwed, pinned) to the form work. Fasteners are not included.



**Pan-Knocker II+ Cordless Concrete Nailer Installation Tool and Pins**

Cat. #	Description	Pack Qty.	Carton Qty.				
DCN891P2	20V Max* Cordless Concrete Nailer Kit	1	-				
Cat. #	Shank Dia. in.	Step Dia. in.	Length in.	Knurl (K)	Finish	Pack Qty.	Carton Qty.
DCN8907804	0.102"	0.088"	0.780"	Yes	Zinc	1000	6000

Fasteners have a head diameter of .250" and are zinc plated in accordance with ASTM B695, Class 5.



**Pan-Knocker II+ Gas Fastening Nailer Installation Tool and Pins**

Cat. #	Description	Pack Qty.	Carton Qty.				
55142-PWR	Trak-It C5 Tool W/Deep Track (1-1/4" Pin)	1	-				
Cat. #	Shank Dia. in.	Step Dia. in.	Length in.	Knurl (K)	Finish	Pack Qty.	Carton Qty.
55330-PWR	0.120"	0.102"	0.730"	Yes	Zinc	800	4000
55342-PWR	0.102"	0.088"	0.780"	Yes	Zinc	800	4000

Fasteners have a head diameter of .250" and are zinc plated in accordance with ASTM B695, Class 5.



**Push-In Thread Couplers**

Cat. No.	Description	Pack Qty.
PFM3613038	3/8"-16 Coupler Push-In Thread	20
PFM3613012	1/2"-13 Coupler Push-In Thread	20

Push-In couplers have one end that does not require turning threaded rod elements during installation which can be ideal for applications such as mounting prefabricated hardware and hanger assemblies.

