

# ICC-ES Evaluation Report

**ESR-5642**

Reissued March 2026

This report also contains:

- [City of LA Supplement](#)


Subject to renewal March 2027

- [CA Supplement](#)

- [FL Supplement w/ HVHZ](#)

ICC-ES Evaluation Reports are not to be construed as representing aesthetics or any other attributes not specifically addressed, nor are they to be construed as an endorsement of the subject of the report or a recommendation for its use. There is no warranty by ICC Evaluation Service, LLC, express or implied, as to any finding or other matter in this report, or as to any product covered by the report.

Copyright © 2026 ICC Evaluation Service, LLC. All rights reserved.

<p><b>DIVISION: 04 00 00— MASONRY</b></p> <p><b>Section: 04 05 19.16— Masonry Anchors</b></p>	<p><b>REPORT HOLDER:</b></p> <p><b>ALLFASTENERS USA LLC</b></p>	<p><b>EVALUATION SUBJECT:</b></p> <p><b>ETB WEDGE ANCHORS IN CRACKED AND UNCRAKED GROUTED CONCRETE MASONRY UNIT WALLS</b></p>	
---	---	---	---

## 1.0 EVALUATION SCOPE

**Compliance with the following codes:**

- 2024 and 2021 [International Building Code® \(IBC\)](#)
- 2024 and 2021 [International Residential Code® \(IRC\)](#)

**Property evaluated:**

Structural

## 2.0 USES

The 1/4-inch (6.4 mm) ETB Wedge Anchor is used as anchorage in uncracked concrete masonry unit (CMU) walls to anchor building components to grouted lightweight, medium weight, or normal-weight concrete masonry wall construction. The anchor system is designed to resist static, wind, and earthquake (Seismic Design Categories A and B) tension and shear loads.

The 3/8-inch through 3/4-inch (9.5 mm through 19.1 mm) ETB Wedge Anchors are used as anchorage in cracked and uncracked concrete masonry unit (CMU) walls to anchor building components to grouted lightweight, medium weight, or normal-weight concrete masonry wall construction. The anchor system is designed to resist static, wind, and earthquake (Seismic Design Categories A and B) tension and shear loads.

The anchor system is an alternative to cast-in-place anchors described in Section 9.1.3 (2022 and 2016 editions) of TMS 402 as referenced in Section 2108.1 of the IBC. The anchor systems may also be used where an engineered design is submitted in accordance with Section R301.1.3 of the IRC.

## 3.0 DESCRIPTION

### 3.1 ETB Wedge Anchor:

Anchors are torque-controlled, mechanical expansion anchors consisting of an anchor body, expansion clip, nut and washer. A typical anchor is shown in [Figure 4](#) of this report. The anchor bodies are manufactured by cold forming from carbon steel materials conforming to JIS G 3507. The zinc plating on the anchor body complies with ASTM B633 SC1 type III, with a minimum 0.0002 inch (5 µm) thickness. The expansion clip is fabricated from low carbon steel conforming to JIS G 3141. The sherardized coating of the clips complies with EN 13811 Class 15 with a minimum 0.0006 inch (15 µm) thickness. The hex nut for the carbon steel ETB anchor conforms to ASME B18.2.2. The washer for the carbon steel ETB anchor conforms to ASME B18.21.1. The available anchor diameters under this report are: 1/4 inch, 3/8 inch, 1/2 inch, 5/8 inch, and 3/4 inch.

The anchor body has a tapered mandrel formed on the installed end of the anchor and a threaded section at the opposite end. The taper of the mandrel increases in diameter towards the installed end of the anchor. The three-segment expansion clip wraps around the tapered mandrel. Before installation, this expansion clip is free to rotate about the mandrel. The anchor is set by applying torque to the hex nut; the mandrel is drawn into the expansion clip, which engages the drilled hole and transfers the load to the base material.

**3.2 Grout-filled Concrete Masonry:**

Grouted concrete masonry must comply with Chapter 21 of the IBC. The compressive strength of masonry,  $f'_m$ , at 28 days, must be a minimum of 1,500 psi (10.3 MPa). Grouted concrete masonry must be constructed from the following materials:

**3.2.1 Concrete Masonry Units (CMUs):** Grouted concrete masonry walls must be constructed from minimum lightweight, medium-weight or normal-weight, closed-end or open-end concrete masonry units (CMUs) conforming to ASTM C90. The minimum allowable nominal size of the CMU is 8 inches (203 mm) wide by 8 inches (203 mm) high by 16 inches (406 mm) long.

**3.2.2 Grout:** Grout must comply with Section 2103.3 of the 2024 and 2021 IBC or Section R606.2.12 of the 2024 and 2021 IRC, as applicable. Alternatively, the grout must have a minimum compressive strength, when tested in accordance with ASTM C1019, equal to its specified strength, but not less than 2,000 psi (13.8 MPa).

**3.2.3 Mortar:** Mortar must be Type N, S, or M, prepared in accordance with Section 2103.2.1 of the 2024 and 2021 IBC, or Section R606.2.8 of the 2024 or 2021 IRC, as applicable.

**4.0 DESIGN AND INSTALLATION**

**4.1 Strength Design of anchors in Grouted Concrete Masonry Unit Construction:**

**4.1.1 General:** Sections 4.1 and 4.2 provide strength design requirements for anchors used in grouted concrete masonry unit construction, where anchors are used to transmit structural loads by means of tension, shear, or a combination of tension and shear.

Strength design of mechanical anchors in fully grouted concrete masonry unit construction shall be conducted in accordance with the provisions for the design of mechanical anchors in concrete in *ACI 318-19 Chapter 17*, and TMS 402 (-22 and -16) as modified by the sections that follow. Design in accordance with this report cannot be conducted without reference to *ACI 318-19* with the deletions and modifications summarized in [Table 4.1](#) and TMS 402-22 Eq. 9-5 or TMS 402-16 Eq. 9-7.

This report references sections, tables, and figures in both this report and ACI 318, with the following method used to distinguish between the two document references:

- References to sections, tables, and figures originating from ACI 318 are *italicized*.
- References to sections, tables, and figures originating from this report do not have any special font treatment, for example Section 4.1.2.

Where language from ACI 318 is directly referenced, the following modifications generally apply:

- The term “masonry” shall be substituted for the term “concrete” wherever it occurs.
- The modification factor to reflect the reduced mechanical properties for mixtures with lightweight aggregate and lightweight units,  $\lambda_a$ , shall be taken as 1.0.

The following terms shall be replaced wherever they occur:

<b>ACI 318-19 term</b>	<b>Replacement term</b>
$f'_c$	$f'_m$
$N_{cb}, N_{cbg}$	$N_{mb}, N_{mbg}$
$V_{cb}, V_{cbg}$	$V_{mb}, V_{mbg}$
$V_{cp}, V_{cpg}$	$V_{mp}, V_{mpg}$

**4.1.2** Restrictions for anchor placement are noted in [Table 1](#) and shown in [Figure 2](#). For CMU construction with closed-end blocks and hollow head joints, in addition to the ends and edges of walls, the nearest head joint on a horizontal projection from the anchor shall be treated as an edge for design purposes. The minimum distance from the nearest adjacent head joint shall be the  $C_{min,HJ}$  value provided in [Table 1](#), which is measured from the centerline of the head joint in CMU construction with hollow head joints. For anchor groups installed in CMU construction with solid head joints, the nearest head joint outside of the group on a horizontal projection to the group shall be treated as an edge. If open-ended units are employed, only the ends and edges of walls

shall be considered for edge distance determination. For horizontal ledgers in fully-grouted CMU walls with hollow head joint applications, see Section 4.2.21.

**4.2 ACI Modifications Required for Design:** [Table 4.1](#) provides a summary of all applicable *ACI 318-19* sections for the design of mechanical anchors in fully grouted masonry. Where applicable, modifying sections contained within this report are also provided.

**4.2.1** *ACI 318-19 Section 17.1.1 and 17.1.3* apply with the general changes prescribed in Section 4.1.1.

**4.2.2** In lieu of *ACI 318-19 Section 17.1.2*: Design provisions are included for post-installed expansion (torque-controlled) anchors that meet the assessment criteria of AC01.

**4.2.3** *ACI 318-19 Section 17.1.4, 17.2.1, 17.4.1, and 17.5.1.3.1* apply with the general changes prescribed in Section 4.1.1.

**4.2.4** *ACI 318-19 Section 17.3.1* applies with the general changes prescribed in Section 4.1.1.

**4.2.5** In lieu of *ACI 318-19 Section 17.5.2*: The design of anchors shall be in accordance with [Table 4.2](#).

**4.2.6** *ACI 318-19 Section 17.5.2.3* applies with the general changes prescribed in Section 4.1.1.

**4.2.7** *ACI 318-19 Section 17.5.1.2* applies with the general changes prescribed in Section 4.1.1.

**4.2.8** In lieu of *ACI 318-19 Section 17.5.3*: Strength reduction factor  $\phi$  for anchors in masonry shall be as follows when the LRFD load combinations of ASCE 7 are used:

- For steel capacity of ductile steel elements as defined in *ACI 318-19 Section 2.3*,  $\phi$  shall be taken as 0.75 in tension and 0.65 in shear. Where the ductility requirements of ACI 318 are not met,  $\phi$  shall be taken as 0.65 in tension and 0.60 in shear.
- For shear crushing capacity,  $\phi$  shall be taken as 0.50.
- For cases where the nominal strength of anchors in masonry is controlled by masonry breakout or pullout strength in tension,  $\phi$  shall be taken as 0.65 for anchors qualifying for Category 1 and 0.55 for anchors qualifying for Category 2.
- For cases where the nominal strength of anchors in masonry is controlled by masonry failure modes in shear,  $\phi$  shall be taken as 0.70.

**4.2.9** *ACI 318-19 Section 17.6.1* applies with the general changes prescribed in Section 4.1.1.

**4.2.10** In lieu of *ACI 318-19 Section 17.6.2.1*: The nominal breakout strength in tension,  $N_{mb}$  of a single anchor or  $N_{mbg}$  of a group of anchors, shall not exceed:

- For a single anchor:

$$N_{mb} = \frac{A_{Nm}}{A_{Nmo}} \Psi_{ed,N,m} \Psi_{c,N,m} N_{b,m} \quad (17.6.2.1a)$$

- For a group of anchors:

$$N_{mbg} = \frac{A_{Nm}}{A_{Nmo}} \Psi_{ec,N,m} \Psi_{ed,N,m} \Psi_{c,N,m} N_{b,m} \quad (17.6.2.1b)$$

Factors  $\Psi_{ec,N,m}$ ,  $\Psi_{ed,N,m}$ , and  $\Psi_{c,N,m}$  are defined in *ACI 318-19 Section 17.6.2.3-17.6.2.5*.  $A_{Nm}$  is the projected masonry failure area of a single anchor or group of anchors that shall be approximated as the base of the rectilinear geometrical figure that results from projecting the failure surface outward  $1.5h_{ef}$  from the centerlines of the anchor, or, in the case of a group of anchors, from a line through a row of adjacent anchors.  $A_{Nm}$  shall not exceed  $n \cdot A_{Nmo}$ , where  $n$  is the number of anchors in the group that resist tension.  $A_{Nmo}$  is the projected masonry failure area of a single anchor with an edge distance equal to or greater than  $1.5h_{ef}$ .

$$A_{Nmo} = 9h_{ef}^2 \quad (17.6.2.1.4)$$

**4.2.11** In lieu of *ACI 318-19 Section 17.6.2.2*: The basic masonry breakout strength of a single anchor in tension in cracked masonry,  $N_{b,m}$ , shall not exceed:

$$N_{b,m} = k_m \sqrt{f'_m} h_{ef}^{1.5} \quad (17.6.2.2.1)$$

where

$$\begin{aligned} k_m &= \text{effectiveness factor for breakout} \\ &\quad \text{strength in masonry} \\ &= \alpha_{masonry} \cdot k_c \end{aligned}$$

$k_c$	=	effectiveness factor for breakout strength in concrete
	=	17; and
$\alpha_{masonry}$	=	reduction factor for the inhomogeneity of masonry materials in breakout strength determination.
	=	0.7

**4.2.12** ACI 318-19 Section 17.6.2.1.2 & 17.6.2.3-17.6.2.4 apply with the general changes prescribed in Section 4.1.1.

**4.2.13** In lieu of ACI 318-19 Section 17.6.2.5: The basic masonry breakout strength of a single anchor in tension,  $N_{b,m}$ , must be calculated using the values of  $k_{m,cr}$  and  $k_{m,uncr}$  as described in Tables 2 and 3. Where analysis indicates no cracking is anticipated,  $N_{b,m}$  must be calculated using  $k_{m,uncr}$  and  $\Psi_{c,N,m} = 1.0$ .

**4.2.14** ACI 318-19 Section 17.6.2.6 need not be considered since the modification factor for post installed anchors,  $\Psi_{cp,N}$ , is not included in Eq. 17.6.2.1a & 17.6.2.1b.

**4.2.15** In lieu of ACI 318-19 Section 17.6.3.1: The nominal pullout strength of a single post-installed anchor in tension shall not exceed:

$$N_{pn} = \Psi_{m,p} N_p \quad (17.6.3.1)$$

where  $\Psi_{m,p}$  is defined in ACI 318-19 Section 17.6.3.3.

**4.2.16** In lieu of ACI 318-19 Section 17.6.3.2.1: The nominal pullout strength of a single anchor in cracked and uncracked masonry,  $N_{p,cr}$  and  $N_{p,uncr}$ , respectively, is given in Tables 2 and 3 of this report, and shall not exceed the breakout strength calculated in accordance with Section 4.2.12 associated with  $f'_m$ .

**4.2.17** The following apply with the general changes prescribed in Section 4.1.1:

1. ACI 318-19 17.6.3.3
2. ACI 318-19 Section 17.7.1 excluding Sections 17.7.1.2a & 17.7.1.2c
3. ACI 318-19 Section 17.7.2.1-17.7.2.2.1
4. ACI 318-19 Sections 17.7.2.1.2 & 17.7.2.3-17.7.2.4
5. ACI 318-19 Section 17.7.2.6
6. ACI 318-19 Section 17.7.3
7. ACI 318-19 Section 17.8-17.9
8. ACI 318-19 Section 17.2.5

**4.2.18** In lieu of ACI 318-19 Section 17.7.2.5: For anchors located in a region of masonry construction where cracking is anticipated,  $\Psi_{m,v}$  shall be taken as 1.0. For cases where analysis indicates no cracking at service levels, it shall be permitted to take  $\Psi_{m,v}$  as 1.4.

**4.2.19** In lieu of ACI 318-19 Section 17.9: Minimum edge distances and spacings shall be as given in Table 1 of this report.

**4.2.20** [In addition to the ACI 318 provisions] Masonry crushing strength for anchors in shear shall be calculated in accordance with TMS 402-16 Eq. 9-7 (TMS 402-22 Eq. 9-5). The nominal strength of an anchor in shear as governed by masonry crushing,  $V_{mc}$ , shall be calculated using Eq. (4-1).

$$V_{mc} = 1750 \cdot \sqrt[4]{f'_m A_{se,v}} \quad (4-1)$$

**4.2.21** [In addition to the ACI 318 provisions] Determination of shear capacity for anchors in horizontal ledgers in fully grouted CMU walls with hollow head joint applications with an assumed masonry unit length of 16 inches, standard:

Where six or more anchors are placed at uniform horizontal spacing in continuous wood or steel ledgers connecting floor and roof diaphragms to fully grouted CMU walls constructed with hollow head joints (using closed-end block), the horizontal and vertical shear capacity of the anchors may be permitted to be calculated in accordance with Eq. (4-2) and Eq. (4-3), respectively, in lieu of Section 4.1.2.

$$v_{mb,horiz} = 0.75 \cdot V_{gov,horiz} \cdot \frac{12}{s_{horiz}} \quad (4-2)$$

$$v_{mb,vert} = 0.75 \cdot V_{gov,vert} \cdot \frac{12}{s_{horiz}} \quad (4-3)$$

where

$s_{horiz}$  = horizontal anchor spacing in the ledger, (in.). For anchor spacings that are multiples of 8 inches, locate the first anchor in the ledger at least 2 inches from the head joint and the center of the block. For other anchor spacings, minimum edge distance as specified in the evaluation report shall apply.

$$V_{gov,horiz} = \min(V_{sa}, V_{mb,4}, V_{mc}, V_{mp,4}), \text{ (lb)}$$

$$V_{gov,vert} = \min(V_{sa}, 2 \cdot V_{mb,4}, V_{mc}, V_{mp,4}), \text{ (lb)}$$

$V_{sa}$  = shear capacity for a single anchor calculated in accordance with *ACI 318-19 Section 17.7.1.2, (lb)*

$V_{mb,4}$  = breakout capacity for a single anchor with edge distance of 4 inches, (lb)

$V_{mc}$  = crushing capacity for a single anchor calculated in accordance with Eq. (4-1), (lb)

$V_{mp,4}$  = pryout capacity for a single anchor with edge distance of 4 inches, (lb)

Where anchors are spaced at 8 inches on center or another multiple of 8 inches on center, multiply the calculated  $V_{mb,horiz}$  and  $V_{mb,vert}$  by  $\frac{4}{3}$ .

**4.2.22** Interaction shall be calculated in compliance with *ACI 318-19 Section 17.8* as follows:

1. If  $\frac{V_{ua}}{\phi V_n} \leq 0.2$  for the governing strength in shear, then full strength in tension shall be permitted:  $\phi N_n \geq N_{ua}$ .
2. If  $\frac{N_{ua}}{\phi N_n} \leq 0.2$  for the governing strength in tension, then full strength in shear shall be permitted:  $\phi V_n \geq V_{ua}$ .
3. For all other cases:

$$\frac{N_{ua}}{\phi N_n} + \frac{V_{ua}}{\phi V_n} \leq 1.2 \quad (17.8.3)$$

**4.2.23** Satisfying the parabolic equation complying with *ACI 318-19 Section R17.8* may be used in lieu of satisfying Section 4.2.22. The parabolic equation is given as:

$$\left(\frac{N_{ua}}{\phi N_n}\right)^{5/3} + \left(\frac{V_{ua}}{\phi V_n}\right)^{5/3} \leq 1.0$$

### 4.3 Strength Design of Anchors in Partially Grouted Concrete Masonry Unit Construction:

**4.3.1** In all cases, the minimum distance from hollow head joints shall be the  $c_{min,HJ}$  value provided in [Table 1](#), measured from the centerline of the head joint.

**4.3.2** Anchors located in grouted cells shall be designed in accordance with Sections 4.1 and 4.2, whereby the distance to the edge of the ungrouted cell shall be taken as a free edge.

### 4.4 Conversion of Strength Design to Allowable Stress Design (ASD):

For mechanical anchors designed using load combinations in accordance with IBC Section 1605.3 (Allowable Stress Design), allowable loads shall be established using the equations below:

$$T_{allowable,ASD} = \frac{\phi N_n}{\alpha} \quad (4-4)$$

and

$$V_{allowable,ASD} = \frac{\phi V_n}{\alpha} \quad (4-5)$$

where

$T_{allowable,ASD}$  = Allowable tensile load (lb)

$V_{allowable,ASD}$  = Allowable shear load (lb)

$N_n$  = Lowest design strength of an anchor or anchor group in tension as determined in accordance with this report, as applicable

$V_n$  = Lowest design strength of an anchor or anchor group in shear as determined in accordance with this report

- $\alpha$  = Conversion factor calculated as a weighted average of the load factors for the controlling load combination. In addition,  $\alpha$  shall include all applicable factors to account for non-ductile failure modes and required overstrength; and
- $\phi$  = relevant strength reduction factor for load case and Anchor Category.

#### 4.5 Installation:

Installation parameters are provided in [Table 1](#) and [Figures 1, 2, and 3](#). Anchor locations must comply with this report and plans and specifications approved by the code official. The ETB Wedge Anchors must be installed in accordance with manufacturer's published instructions and this report. In case of conflict, this report governs. Installation in head joints shall only be permitted in fully grouted walls constructed with open-ended units. Anchors must be installed in holes drilled into the masonry using carbide-tipped masonry drill bits complying with ANSI B212.15-1994. Nominal drill bit diameters must be equal to the nominal diameter of the anchors, and holes shall be drilled to a depth allowing proper embedment. Prior to anchor installation, the hole must be cleaned in accordance with the manufacturer's published installation instructions. Anchors shall be driven into the hole using a hammer until the proper embedment depth is achieved. Nuts and washers shall be tightened against the base material or material to be fastened until the appropriate installation torque value specified in [Table 1](#) of this report is achieved.

#### 4.6 Special Inspection:

At a minimum, periodic special inspection under the IBC and IRC must be provided in accordance with Sections 1704 and 1705 of the IBC. Under the IBC, additional requirements as set forth in Sections 1705 and 1706 must be observed, where applicable. The special inspector shall be on the jobsite initially during anchor installation to verify anchor type and dimensions, masonry type, masonry compressive strength, anchor identification, hole dimensions, hole cleaning procedures, spacing, edge distances, masonry unit dimensions, anchor embedment, tightening torque, and adherence to the Manufacturer's Printed Installation Instructions (MPII).

The special inspector shall verify the initial installations of each type and size of mechanical anchor by construction personnel on site. Subsequent installations of the same anchor type and size by the same construction personnel are permitted to be performed in the absence of the special inspector. Any change in the anchor product being installed or in the personnel performing the installation requires an initial inspection. For ongoing installations over an extended period, the special inspector must make regular inspections to confirm correct handling and installation of the product.

### 5.0 CONDITIONS OF USE:

The ETB Wedge Anchors described in this report are suitable alternatives to what is specified in the codes listed in Section 1.0 of this report, subject to the following conditions:

- 5.1 The ETB Wedge Anchors must be installed in accordance with the manufacturer's printed installation instructions (MPII) and this report. In case of conflict, this report governs.
- 5.2 Anchors have been evaluated for use in cracked and uncracked grouted concrete masonry unit (CMU) construction with a minimum compressive strength of 1,500 psi (10.3 MPa) at the time of anchor installation.
- 5.3 Anchor sizes, dimensions, and minimum embedment depths must be as set forth in this report.
- 5.4 Construction documents prepared or reviewed by a registered design professional, where required by the statutes of the jurisdiction in which the project is to be constructed, specifying the ETB Wedge Anchors must indicate compliance with this evaluation report, applicable codes, and must be submitted to the code official for approval.
- 5.5 Anchors installed in the face or the top of fully grouted CMU masonry may be used to resist short-term loading due to wind or seismic forces in structures assigned to Seismic Design Categories A and B under the IBC.

Loads applied to the anchors must be adjusted in accordance with Section 1605.1 of the 2024 or 2021 IBC for strength design or for allowable stress design.

- 5.6 Strength design values shall be established in accordance with Sections 4.1, 4.2, and 4.3 of this report.
- 5.7 Allowable design values shall be established in accordance with Section 4.4 of this report.
- 5.8 Design of anchors in fully grouted CMU construction must avoid location of anchors in hollow head joints.
- 5.9 Since an ICC-ES acceptance criteria for evaluating data to determine the performance of mechanical anchors subjected to fatigue or shock loading is unavailable at this time, the use of these anchors under these conditions is beyond the scope of this report.

**5.10** Anchors are not permitted to support fire-resistive construction. Where not otherwise prohibited by the code, anchors are permitted for installation in fire-resistive construction provided that at least one of the following conditions is fulfilled:

- Anchors are used to resist wind or seismic forces only.
- Anchors that support gravity load-bearing structural elements are within a fire-resistive envelope or a fire-resistive membrane, are protected by approved fire-resistive materials, or have been evaluated for resistance to fire exposure in accordance with recognized standards.
- Anchors are used to support nonstructural elements.

**5.11** The design of anchors must be in accordance with the provisions for cracked masonry where analysis indicates that cracking may occur ( $f_t > f_r$ ) in the vicinity of the anchor due to service loads or deformations over the anchor service life.

**5.12** Use of carbon steel ETB Wedge Anchors must be limited to dry, interior locations.

**5.13** Special inspection must be provided in accordance with Section 4.6 of this report.

**5.14** Anchors are manufactured under a quality control program with inspections conducted by ICC-ES.

## 6.0 EVIDENCE SUBMITTED

Data in accordance with the [ICC-ES Acceptance Criteria for Mechanical Anchors in Cracked and Uncracked Masonry Elements \(AC01\)](#), dated June 2024.

## 7.0 IDENTIFICATION

**7.1** The ICC-ES mark of conformity, electronic labeling, or the evaluation report number (ICC-ES ESR-5642) along with the name, registered trademark, or registered logo of the report holder must be included in the product label.

**7.2** In addition, the anchors are identified by packaging labeled with the manufacturer's contact information, anchor name, and anchor size. The anchors have the letters ETB and the anchor size embossed on the sleeve.

**7.3** The report holder's contact information is the following:

**ALLFASTENERS USA LLC**  
**959 LAKE ROAD**  
**MEDINA, OHIO 44256**  
**(888) 859-6060**  
[www.allfasteners.com](http://www.allfasteners.com)  
[vern.macgregor@allfasteners.com](mailto:vern.macgregor@allfasteners.com)

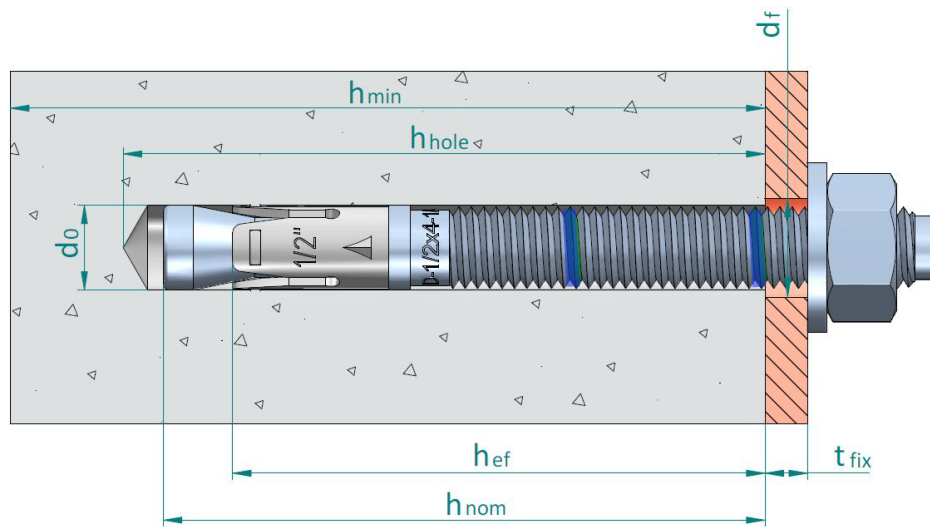


FIGURE 1—ANCHOR DIMENSIONS

TABLE 1— ETB ANCHOR INSTALLATION PARAMETERS<sup>1</sup>

Characteristic	Symbol	Unit	Nominal Anchor Diameter							
			1/4"	3/8"	1/2"		5/8"		3/4"	
Outside Diameter	$d_a$	in (mm)	1/4 (6.4)	3/8 (9.5)	1/2 (12.7)	1/2 (12.7)	5/8 (15.9)	5/8 (15.9)	3/4 (19.1)	3/4 (19.1)
Nominal Embedment Depth	$h_{nom}$	in (mm)	1.68 (43)	2.33 (59)	2.33 (59)	3.59 (91)	3.23 (82)	4.49 (114)	3.74 (95)	5.26 (134)
Effective Embedment Depth	$h_{ef}$	in (mm)	1 1/2 (38)	2 (51)	2 (51)	3 1/4 (83)	2 3/4 (70)	4 (102)	3 1/4 (83)	4 3/4 (121)
Minimum Hole Depth	$h_{hole}$	in (mm)	2 (51)	2 5/8 (67)	2 5/8 (67)	4 (102)	3 1/2 (89)	4 3/4 (121)	4 (102)	5 3/4 (146)
Clearance Hole Diameter	$d_f$	in (mm)	5/16 (7.9)	7/16 (11.1)	9/16 (14.3)		11/16 (17.5)		7/8 (22.2)	
Installation Torque	$T_{inst}$	ft.lb (Nm)	4 (5)	10 (14)	30 (41)		50 (68)		75 (102)	
Minimum Masonry Thickness	$h_{min}$	in (mm)	7 5/8 (194)							
Minimum Distance to Head Joint <sup>2</sup>	$C_{min,HJ}$	in (mm)	2 1/2 (64)							
Critical Edge Distance	$c_{cr}$	in (mm)	2 1/2 (64)	3 (76)	3 (76)	4 7/8 (124)	4 1/8 (105)	6 (152)	4 7/8 (124)	7 1/8 (181)
Minimum Edge Distance and spacing, field of wall	$c_{min}$	in (mm)	2 (51)	6.5 (165)	7 (178)	7 (178)	10 (254)	10 (254)	14 (356)	14 (356)
	$s_{min}$	in (mm)	3 (76)	4 (102)	4 (102)	4 (102)	8 (203)	8 (203)	8 (203)	8 (203)
Minimum Edge Distance and spacing, top of wall <sup>3</sup>	$c_{min,top}$	in (mm)	1 3/4 (44)	2 (51)	3 3/4 (95)	3 3/4 (95)	4 (102)	4 (102)	4 (102)	4 (102)
	$s_{min,top}$	in (mm)	3 3/4 (95)	5 (127)	8 (203)	8 (203)	8 (203)	8 (203)	10 (254)	10 (254)
Minimum Overall Anchor Length	$l_{anch}$	in (mm)	2 1/4 (57)	3 (76)	3 1/2 (89)	4 1/2 (114)	4 1/4 (108)	5 1/2 (140)	5 (127)	6 1/2 (165)
Torque Wrench Socket Size	-	in	7/16	9/16	3/4		15/16		1 1/8	

For SI: 1 inch = 25.4 mm | 1 ft-lbf = 1.356 Nm

<sup>1</sup>The tabulated data is to be used in conjunction with the design criteria given in ACI 318-19 Chapter 17, as applicable.

<sup>2</sup>The minimum distance from the center of an anchor to the centerline of a hollow head joint (vertical mortar joint) is  $C_{min,HJ}$  as shown in Figure 2 is 2.5 inches. See Section 4.1.2.

<sup>3</sup>The minimum end distance from the center of an anchor to the end of the top of the CMU wall is 12 inches.

TABLE 2—ANCHOR DESIGN INFORMATION (UNCRACKED FULLY GROUTED CMU CONSTRUCTION)<sup>1,2</sup>

Characteristic	Symbol	Unit	Nominal Anchor Diameter
			1/4"
Effective Embedment Depth	$h_{ef}$	in (mm)	1 1/2 (38)
Anchor Category	1 or 2	-	2
<b>Steel Strength in Tension and Shear</b>			
Effective Steel Stress Area (Threads)	$A_{se}$	in <sup>2</sup> (mm <sup>2</sup> )	0.0318 (20.5)
Effective Steel Stress Area (Neck)	$A_{se}$	in <sup>2</sup> (mm <sup>2</sup> )	0.0230 (14.8)
Minimum Specified Yield Strength (Threads)	$f_y$	psi (N/mm <sup>2</sup> )	69,500 (480)
Minimum Specified Yield Strength (Neck)	$f_y$	psi (N/mm <sup>2</sup> )	90,500 (624)
Minimum Specified Ultimate Strength (Threads)	$f_{ut}$	psi (N/mm <sup>2</sup> )	87,000 (600)
Steel Strength in Tension	$N_{sa}$	lb (kN)	2,600 (11.6)
Strength Reduction Factor for Steel Failure in Tension	$\phi_{sa}$	-	0.75
Steel Strength in Shear, field of wall	$V_{sa}$	lb (kN)	830 (3.7)
Steel Strength in Shear, top of wall	$V_{sa,top}$	lb (kN)	160 (0.7)
Strength Reduction Factor for Steel Failure in Shear	$\phi_{sa}$	-	0.65
<b>Masonry Pullout Strength in Tension</b>			
Pullout Strength in Uncracked Masonry, field of wall	$N_{p,unscr}$	lb (kN)	320 (1.4)
Pullout Strength in Uncracked Masonry, top of wall	$N_{p,top,unscr}$	lb (kN)	320 (1.4)
Strength Reduction Factor for Pullout Strength in Tension	$\phi_p$	-	0.55
<b>Masonry Breakout Strength in Tension</b>			
Effective Embedment	$h_{ef}$	in. (mm)	1.5 (38)
Effectiveness Factor for Uncracked Masonry	$k_{m,unscr}$	-	16.7
Strength Reduction Factor for Masonry Breakout Strength in Tension	$\phi_{mb}$	-	0.55
Axial stiffness in service load range in uncracked masonry	$\beta_{unscr}$	lb/inch (N/mm)	96,000 (16,800)
Coefficient of variation for axial stiffness in service load range in uncracked masonry	$v_{unscr}$	%	72
Axial stiffness in service load range in uncracked masonry, top of wall	$\beta_{unscr,top}$	lb/inch (N/mm)	23,600 (4,100)
Coefficient of variation for axial stiffness in service load range in uncracked masonry	$v_{unscr,top}$	%	99
<b>Masonry Breakout Strength in Shear</b>			
Nominal Diameter	$d_o$	in (mm)	1/4 (6.4)
Load Bearing Length of Anchor	$l_e$	in (mm)	1 1/2 (38)
Reduction Factor for Masonry Breakout Strength in Shear	$\phi_{mb}$	-	0.70
<b>Masonry Pryout and Crushing Strength in Shear</b>			
Coefficient for Pryout Strength	$k_{mp}$	-	1.0
Reduction Factor for Pryout Strength in Shear	$\phi_{mp}$	-	0.70
Reduction Factor for Crushing Strength in Shear	$\phi_{mc}$	-	0.50

<sup>1</sup>The tabulated data is to be used in conjunction with the design criteria given in ACI 318-19 Chapter 17, as applicable.<sup>2</sup>Anchors meet the ductile requirements of ACI 318.

TABLE 3—ANCHOR DESIGN INFORMATION (CRACKED AND UNCRACKED FULLY GROUTED CMU CONSTRUCTION)<sup>1,2</sup>

Characteristic	Symbol	Units	Nominal Anchor Diameter							
			3/8"	1/2"		5/8"		3/4"		
Effective Embedment Depth	$h_{ef}$	in (mm)	2 (51)	2 (51)	3 1/4 (83)	2 3/4 (70)	4 (102)	3 1/4 (83)	4 3/4 (121)	
Anchor Category	1 or 2	-	1	2		1		1		
<b>Steel Strength in Tension and Shear</b>										
Effective Steel Stress Area (Threads)	$A_{se}$	in <sup>2</sup> (mm <sup>2</sup> )	0.077 (49.7)	0.141 (91.0)		0.226 (145.8)		0.334 (215.5)		
Effective Steel Stress Area (Neck)	$A_{se}$	in <sup>2</sup> (mm <sup>2</sup> )	0.0562 (36.3)	0.100 (64.5)		0.160 (103.2)		0.238 (153.5)		
Minimum Specified Yield Strength (Threads)	$f_y$	psi (N/mm <sup>2</sup> )	69,500 (480)							
Minimum Specified Yield Strength (Neck)	$f_y$	psi (N/mm <sup>2</sup> )	85,000 (585)	85,000 (585)		81,000 (560)		77,000 (530)		
Minimum specified ultimate strength (Threads)	$f_{uta}$	psi (N/mm <sup>2</sup> )	87,000 (600)							
Steel Strength in Tension	$N_{sa}$	lb (kN)	6,125 (27.2)	10,600 (47.2)		16,240 (72.2)		22,730 (101.1)		
Strength Reduction Factor for Steel Failure in Tension	$\phi_{sa}$	-	0.75							
Steel Strength in shear, field of wall	$V_{sa}$	lb (kN)	1600 (7.1)	2250 (10)		3520 (15.7)		5720 (25.4)		
Steel Strength in shear, top of wall	$V_{sa,top}$	lb (kN)	560 (2.5)	1405 (6.2)		1370 (6.1)		2595 (11.5)		
Strength Reduction Factor for Steel Failure in Shear	$\phi_{sa}$	-	0.65							
<b>Masonry Pullout Strength in Tension</b>										
Pullout Strength in Uncracked Masonry, field of wall	$N_{p,uncr}$	lb (kN)	1125 (5.0)	1130 (5.0)	1795 (8.0)	2665 (11.9)	3020 (13.4)	2005 (8.9)	3880 (17.3)	
Pullout Strength in Cracked Masonry, field of wall	$N_{p,cr}$	lb (kN)	515 (2.3)	460 (2.0)	730 (3.3)	1840 (8.2)	2080 (9.3)	2005 (8.9)	3880 (17.3)	
Pullout Strength in uncracked masonry, top of wall	$N_{p,uncr,top}$	lb (kN)	900 (4.0)	870 (3.9)	1795 (8.0)	2510 (11.2)	2565 (11.4)	1620 (7.2)	3880 (17.3)	
Masonry Pullout Cracking Factor	$\psi_{m,p}$	-	1.0							
Strength Reduction Factor for Pullout Strength in Tension	$\phi_p$	-	0.65	0.55		0.65		0.65		
<b>Masonry Breakout Strength in Tension</b>										
Effective Embedment	$h_{ef}$	in. (mm)	2 (51)	2 (51)	3 1/4 (83)	2 3/4 (70)	4 (102)	3 1/4 (83)	4 3/4 (121)	
Effectiveness Factor for Uncracked Masonry	$k_{m,uncr}$	-	16.7							
Effectiveness Factor for Cracked Masonry	$k_{m,cr}$	-	11.9							
Strength Reduction Factor for Masonry Breakout Strength in Tension	$\phi_{mb}$	-	0.65	0.55		0.65		0.65		
Axial stiffness in service load range in uncracked masonry	$\beta_{uncr}$	lb/inch (N/mm)	109,400 (19,200)	83,300 (14,600)	51,200 (9,000)	105,200 (18,400)	87,500 (15,300)	171,800 (30,100)	156,500 (27,400)	
Coefficient of variation for axial stiffness in service load range in uncracked masonry	$v_{uncr}$	%	160	55	45	75	30	45	145	
Axial stiffness in service load range in cracked masonry	$\beta_{cr}$	lb/inch (N/mm)	26,500 (4,600)	64,600 (11,300)	45,200 (8,000)	58,900 (10,300)	70,600 (12,400)	112,700 (19,750)	36,950 (6,500)	
Coefficient of variation for axial stiffness in service load range in cracked masonry	$v_{cr}$	%	60	45	50	55	85	65	25	
Axial stiffness in service load range in masonry, top of wall	$\beta_{cr,top}$	lb/inch (N/mm)	53,100 (9,300)	72,800 (12,750)	48,800 (8,500)	28,750 (5,000)	29,500 (5,200)	14,500 (2,550)	37,900 (6,600)	
Coefficient of variation for axial stiffness in service load range in masonry, top of wall	$v_{cr,top}$	%	135	105	80	75	60	55	45	
<b>Masonry Breakout Strength in Shear</b>										
Nominal Diameter	$d_o$	in	3/8	1/2		5/8		3/4		
Load Bearing Length of Anchor	$l_e$	in (mm)	2 (51)	2 (51)	3 1/4 (83)	2 3/4 (70)	4 (102)	3 1/4 (83)	4 3/4 (121)	
Reduction Factor for Masonry Breakout Strength in Shear	$\phi_{mb}$	-	0.70							
<b>Masonry Pryout and Crushing Strength in Shear</b>										
Coefficient for Pryout Strength	$k_{mp}$	-	1.0	1.0	2.0	2.0	2.0	2.0	2.0	
Reduction Factor for Pryout Strength in Shear	$\phi_{mp}$	-	0.70							
Reduction Factor for Crushing Strength in Shear	$\phi_{mc}$	-	0.50							

1. The tabulated data is to be used in conjunction with the design criteria given in ACI 318-19 Chapter 17, as applicable.  
 2. Anchors meet the ductile requirements of ACI 318.

**TABLE 4.1 — ACI 318-19 SECTIONS APPLICABLE OR MODIFIED BY THIS REPORT**

ACI 318-19 Section	Modified by this Report Section:
2.2	Unchanged*
2.3	
17.1.1, 17.1.3	
17.1.2	Section 4.2.2
17.1.4, 17.2.1, 17.4.1, & 17.5.1.3.1	Unchanged*
17.3.1	Unchanged*
17.5.2	Section 4.2.5
17.5.2.3	Unchanged*
17.5.1.2	
17.5.3	Section 4.2.8
17.6.1	Unchanged*
17.6.2.1	Section 4.2.10
17.6.2.2	Section 4.2.11
17.6.2.1.2 & 17.6.2.3 – 17.6.2.4	Unchanged*
17.6.2.5	Section 4.2.13
17.6.2.6	Section 4.2.14
17.6.3.1	Section 4.2.15
17.6.3.2.1	Section 4.2.16
17.6.3.3	Section 4.2.17
17.7.1 excluding 17.7.1.2a & 17.7.1.2c	Unchanged*
17.7.2.1-17.7.2.2.1	
17.7.2.1.2 & 17.7.2.3 – 17.7.2.4	
17.7.2.5	Section 4.2.18
17.7.2.6	Unchanged*
17.7.3	
17.8-17.9	
R17.8	
17.2.5	

\*Sections marked as unchanged adopt the general changes prescribed in Section 4.1.1.

**TABLE 4.2 — REQUIRED STRENGTH OF ANCHORS IN FULLY GROUTED CMU**

Failure Mode	Single Anchor	Anchor Group <sup>1</sup>	
		Individual Anchor in a Group	Anchors as a Group
Steel Strength in Tension	$\phi N_{sa} \geq N_{ua}$	$\phi N_{sa} \geq N_{ua,i}$	
Masonry Breakout Strength in Tension	$\phi N_{mb} \geq N_{ua}$		$\phi N_{mbg} \geq N_{ua,g}$
Pullout Strength in Tension	$\phi N_{pn} \geq N_{ua}$	$\phi N_{pn} \geq N_{ua,i}$	
Steel Strength in Shear	$\phi V_{sa} \geq V_{ua}$	$\phi V_{sa} \geq V_{ua,i}$	
Masonry Breakout Strength in Shear	$\phi V_{mb} \geq V_{ua}$		$\phi V_{mbg} \geq V_{ua,g}$
Masonry Crushing Strength in Shear	$\phi V_{mc} \geq V_{ua}$	$\phi V_{mc} \geq V_{ua,i}$	
Masonry Pryout Strength in Shear	$\phi V_{mp} \geq V_{ua}$		$\phi V_{mpg} \geq V_{ua,g}$

<sup>1</sup>Required strengths for steel, pullout, and crushing failure modes shall be calculated for the most highly stressed anchor in the group.

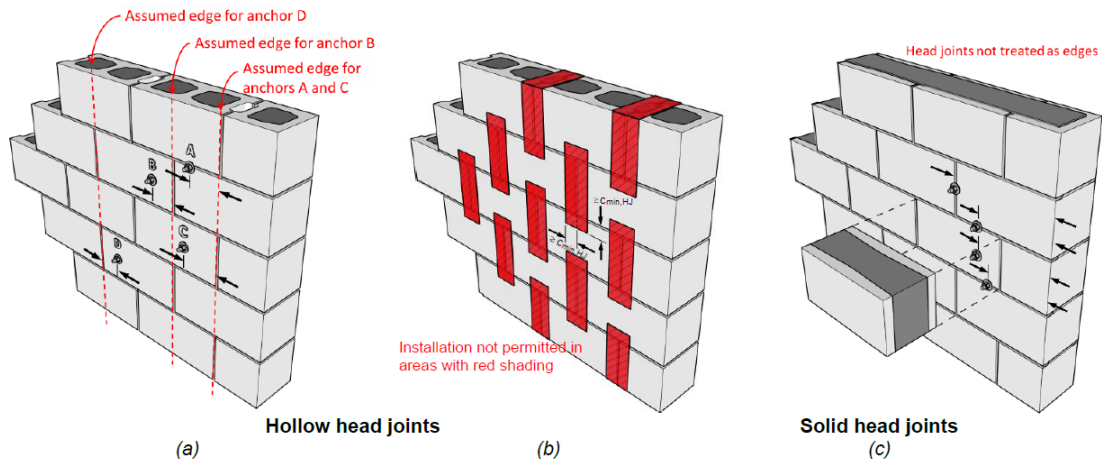


FIGURE 2—(a) Edge distance considerations in fully grouted CMU construction with hollow head joints, (b) exclusion zones in fully grouted construction with hollow head joints, and (c) edge distance considerations in fully grouted CMU construction with solid head joints. Note: dimensions to upper and lower edges omitted for clarity.

TABLE 5—ETB WEDGE ANCHOR LENGTH CODE IDENTIFICATION SYSTEM

Length ID marking on threaded stud head		A	B	C	D	E	F	G	H	I	J	K	L	M	N	O	P	Q
Overall anchor length (in.)	From	1½	2	2½	3	3½	4	4½	5	5½	6	6½	7	7½	8	8½	9	9½
	Up to, but not including	2	2½	3	3½	4	4½	5	5½	6	6½	7	7½	8	8½	9	9½	10




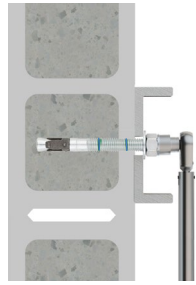
	<p><b>1. DRILLING</b> Drill a hole into the base material of the correct diameter and depth using a drill bit that meets the requirements of ANSI B212.15</p>
	<p><b>2. BLOW AND CLEAN</b> Remove dust and debris from hole using a hand pump, compressed air or a vacuum to remove loose particles left from drilling.</p>
	<p><b>3. INSTALL</b> Position the washer on the anchor and thread on the nut. If installing through a fixture drive the anchor through the fixture into the hole. Be sure the anchor is driven until the corresponding green mark depth is levelled with the base material surface. Use a hammer if necessary.</p>
	<p><b>4. APPLY THE TORQUE</b> Tighten the anchor with a torque wrench by applying the required installation torque, <math>T_{ins}</math>. Note: the threaded stud will draw up during tightening of the nut the expansion wedge (nut) remains in the original position. Once installed, the total length of the anchor may be checked using the letter on the head</p>

FIGURE 3—MANUFACTURER’S PUBLISHED INSTALLATION INSTRUCTIONS

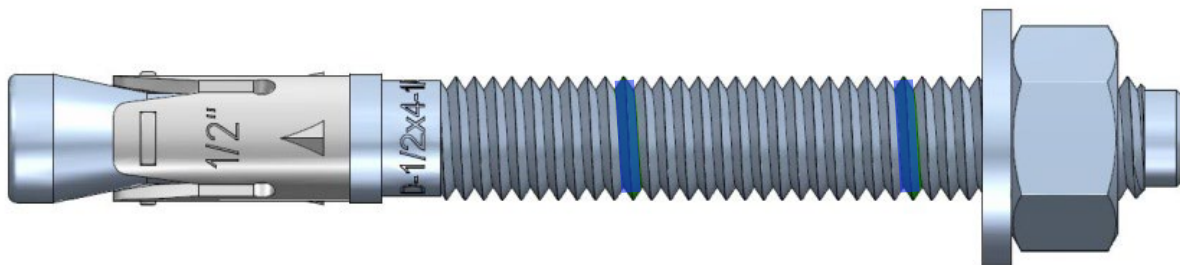


FIGURE 4—ETB WEDGE ANCHOR

Illustrative procedure of Allowable Stress Design calculation.

<p>Given data:                  2 anchors ETB 3/8"x 2" deep embedment depth                  8-inch Concrete masonry unit CMU having minimum net area compressive strength of 3,000 psi with Type M or S mortar, cracked (not to scale). Anchors must be embedded in grouted cells. Fully-grouted concrete masonry wall must be constructed in accordance with TMS 402.                  Grout strength: 3,000 psi, cracked  <math>h_{ef} = 2.00</math> in                  Anchor Layout: as per sketch                  Installation: field of wall                  Static or quasi-static loads                  Load: tension + shear towards upper edge</p>	
---	--

Step	AC01 calculation section 3.3	ESR
1	Verify spacing / edge distance / member thickness $s = 4 \text{ in} \geq 5 \frac{1}{2} \text{ in} \rightarrow \text{verified}$ $c_{a1} = 6 \frac{1}{2} \text{ in} \geq 6 \frac{1}{2} \text{ in} \rightarrow \text{verified}$ $c_{a2} = 7 \text{ in} \geq 6 \frac{1}{2} \text{ in} \rightarrow \text{verified}$	4.1.2; <a href="#">Table 1</a>
2	Calculation of steel capacity on a single fastener loaded in tension $\phi N_{sa} = (0.75) (6,125) = 4,594 \text{ lbf}$ Group of fasteners $\phi N_s = n \phi N_{sa} = (2) (4,594) = \mathbf{9,188 \text{ lbf}}$	4.2.8; <a href="#">Table 3</a>
3	Calculation of masonry strength capacity of the group of fasteners loaded in tension $\phi N_{mbg} = \phi \frac{A_{Nm}}{A_{Nm0}} \psi_{ec,N,m} \psi_{ed,N,m} \psi_{c,N,m} N_{b,m}$ 3.1 $A_{Nm0} = 9 (h_{ef})^2 = 9 (2.0)^2 = 36.00$ $A_{Nm} = (1.5 h_{ef} + 1.5 h_{ef}) (1.5 h_{ef} + s + 1.5 h_{ef}) = (3.0 + 3.0) (3.0 + 4 + 3.0) = 60.00$ 3.2 No load eccentricity $\rightarrow e_N = 0 \rightarrow \psi_{ec,N,m} = 1.00$ 3.3 $c_{a,min} > 1.5 h_{ef} \rightarrow \psi_{ed,N,m} = 1.00$ 3.4 Cracked masonry $\rightarrow \psi_{c,N,m} = 1.00$ 3.5 $N_{b,m,cr} = k_{m,cr} \sqrt{f'_m} h_{ef}^{1.5} = \alpha_{masonry} k_{c,cr} \sqrt{f'_m} h_{ef}^{1.5} = (0.7) (17) \sqrt{3000} (2.00)^{1.5} = 1,844 \text{ lbf}$ thus 3.6 $\phi N_{mbg} = (0.65) \frac{60.00}{36.00} (1.0)(1.0)(1.0)(1,844) = \mathbf{1,998 \text{ lbf}}$	4.2.9 4.2.9; <a href="#">Table 1</a> 4.2.9; <a href="#">Table 1</a> 4.2.9 4.2.10; <a href="#">Table 1</a> 4.2.9
4	Calculation of pull out strength on single fastener loaded in tension $\phi N_{pm} = \phi \psi_{m,p} N_p = (0.65)(1.00) (515) = 335 \text{ lbf}$ Group of fasteners $\phi N_{mpg} = n \phi N_{mp} = (2) (335) = \mathbf{669 \text{ lbf}}$	4.2.15; <a href="#">Table 3</a>
5	Governing tension strength: Minimum value of steel, concrete breakout, pull out: $\phi N_{n,m} = \min [\phi N_{sa}; \phi N_{mbg}; \phi N_{pm}] = \mathbf{669 \text{ lbf}}$	
6	Calculation of conversion factor $\alpha$ $\alpha = (1.2) D + (1.6) L = (1.2) (0.30) + (1.6) (0.70) = \mathbf{1.48}$	4.3.1
7	Calculation of allowable stress design in tension $T_{allowable,ASD} = \frac{\phi N_{n,m}}{\alpha} = \frac{669}{1.48} = \mathbf{452 \text{ lbf}}$	4.3.1
8	Calculation of steel capacity on a single fastener loaded in shear $\phi V_{sa} = (0.65) (1,600) = 1,040 \text{ lbf}$ Group of fasteners $\phi V_m = n \phi V_{sa} = (2) (1,040) = \mathbf{2,080 \text{ lbf}}$	<a href="#">Table 3</a>

FIGURE 5- SAMPLE CALCULATION FOR ALLOWABLE STRESS DESIGN

Step	AC01 calculation section 3.3	ESR
9	Calculation of masonry edge capacity on the group of fasteners loaded in shear	<a href="#">Table 3</a>
9.1	$\phi V_{mbg} = \phi \frac{A_{Vm}}{A_{Vm0}} \psi_{ec,V,m} \psi_{ed,V,m} \psi_{c,V,m} \psi_{h,V,m} V_{b,m}$	4.2.17
9.2	$A_{Vm0} = 4.5 (c_{a1})^2 = 4.5 (6.5)^2 = 190.12$	4.2.17, <a href="#">Table 1</a>
9.3	$A_{Vm} = (h_a) (c_{a2} + s + 1.5 c_{a1}) = (7.625) (7.0 + 4.0 + 1.5 \cdot 6.5) = 158.22$	
9.4	No load eccentricity $\rightarrow e_v = 0 \rightarrow \psi_{ec,V,m} = 1.00$	4.2.17
9.5	$c_{a2} < 1.5 c_{a1} \rightarrow \psi_{ed,V,m} = 0.7 + 0.3 \frac{c_{a2}}{1.5 c_{a1}} = 0.915$	4.2.17
9.6	Cracked masonry $\rightarrow \psi_{c,V,m} = 1.00$	4.2.18
9.7	$\psi_{h,V,m} = \sqrt{\frac{1.5 c_a}{h_a}} = \sqrt{\frac{1.5 \cdot 6.5}{7.625}} \rightarrow 1.00$	4.2.17
9.8	$V_{b,m} = \min \left[ 7 \left( \frac{l_c}{d_a} \right)^{0.2} \sqrt{d_a} \sqrt{f'_m} c_{a1}^{1.5}; 9 \sqrt{f'_m} c_{a1}^{1.5} \right]$ $= \min \left[ 7 \left( \frac{2.0}{0.375} \right)^{0.2} \sqrt{0.375} \sqrt{3000} 6.5^{1.5}; 9 \sqrt{3000} 6.5^{1.5} \right]$ $= \min [5,438; 8,169] = 5,438 \text{ lbf}$  thus	
9.9	$\phi V_{mbg} = (0.70) \frac{158.22}{190.12} (1.00)(0.915)(1.00)(1.00)(5,438) = \mathbf{2,899 \text{ lbf}}$	4.2.17
10	Calculation of shear prout capacity $\phi V_{cp,m} = \phi k_{cp} N_{mpg} = (0.70) (1.0) (1,026) = \mathbf{718 \text{ lbf}}$	4.2.17, <a href="#">Table 3</a>
11	Calculation of masonry crushing strength on a single fastener loaded in shear $\phi V_{mc} = \phi 1750 \sqrt[4]{f'_m A_{se,V}} = (0.50)(1750) \sqrt[4]{(3000)(0.077)} = 4,199 \text{ lbf}$  Group of fasteners $\phi V_m = n \phi V_m = (2) (3,411) = \mathbf{6,822 \text{ lbf}}$	<a href="#">Table 3</a>
12	Calculation of shear capacity for bolts in horizontal ledgers It does not apply, since there are less than 6 anchors	4.2.21
13	Governing shear strength: Minimum value of steel, masonry breakout, masonry, masonry prout, masonry crushing: $\phi V_{n,m} = \min [\phi V_{sa}; \phi V_{mbg}; \phi V_{pcp,m}; \phi V_{mc}] = \mathbf{718 \text{ lbf}}$	
14	Calculation of allowable stress design in shear $V_{allowable,ASD} = \frac{\phi V_{n,m}}{\alpha} = \frac{718}{1.48} = \mathbf{485 \text{ lbf}}$	4.3.1

FIGURE 5- SAMPLE CALCULATION FOR ALLOWABLE STRESS DESIGN (CONTINUED)

DIVISION: 04 00 00—MASONRY  
Section: 04 05 19.16—Masonry Anchors

**REPORT HOLDER:**

ALLFASTENERS USA LLC

**EVALUATION SUBJECT:**

ETB WEDGE ANCHORS IN CRACKED AND UNCRACKED GROUTED CONCRETE MASONRY UNIT WALLS

**1.0 REPORT PURPOSE AND SCOPE****Purpose:**

The purpose of this evaluation report supplement is to indicate that the ETB wedge anchors, described in ICC-ES evaluation report [ESR-5642](#), have also been evaluated for compliance with the codes noted below as adopted by the Los Angeles Department of Building and Safety (LADBS).

**Applicable code editions:**

- 2023 *City of Los Angeles Building Code* ([LABC](#))
- 2023 *City of Los Angeles Residential Code* ([LARC](#))

**2.0 CONCLUSIONS**

The ETB wedge anchors, described in Sections 2.0 through 7.0 of the evaluation report [ESR-5642](#), comply with LABC Chapter 21, and the LARC, and are subject to the conditions of use described in this supplement.

**3.0 CONDITIONS OF USE**

The ETB wedge anchors described in this evaluation report supplement must comply with all of the following conditions:

- All applicable sections in the evaluation report [ESR-5642](#)
- The design, installation, conditions of use and identification of the ETB wedge anchors are in accordance with the 2021 *International Building Code*® (IBC) provisions noted in the evaluation report [ESR-5642](#).
- The design, installation and inspection are in accordance with additional requirements of LABC Chapters 16, 17 and City of Los Angeles Information Bulletin P/BC 2020-092, as applicable.
- Under the LARC, an engineered design in accordance with LARC Section R301.1.3 must be submitted.
- The allowable design values listed in the evaluation report and tables are for the connection of the anchors to fully grouted masonry. The connection between the anchors and the connected members shall be checked for capacity (which may govern).

This supplement expires concurrently with the evaluation report, reissued March 2026.

**DIVISION: 04 00 00—MASONRY**  
**Section: 04 05 19.16—Masonry Anchors**

**REPORT HOLDER:**

**ALLFASTENERS USA LLC**

**EVALUATION SUBJECT:**

**ETB WEDGE ANCHORS IN CRACKED AND UNCRACKED GROUTED CONCRETE MASONRY UNIT WALLS**

**1.0 REPORT PURPOSE AND SCOPE**

**Purpose:**

The purpose of this evaluation report supplement is to indicate that the ETB wedge anchors, described in ICC-ES evaluation report [ESR-5642](#), have also been evaluated for compliance with the codes noted below.

**Applicable code edition(s):**

- 2022 California Building Code (CBC)

For evaluation of applicable chapters adopted by the California Office of Statewide Health Planning and Development (OSHPD) AKA: California Department of Health Care Access and Information (HCAI) and the Division of State Architect (DSA), see Sections 2.1.1 and 2.1.2 below.

- 2022 California Residential Code (CRC)

**2.0 CONCLUSIONS**

**2.1 CBC:**

The ETB wedge anchors, described in Sections 2.0 through 7.0 of the evaluation report [ESR-5642](#), comply with CBC Chapter 21, provided the design and installation are in accordance with the 2021 *International Building Code*® (IBC) provisions noted in the evaluation report and the additional requirements of CBC Chapters 16, 17 and 21, as applicable.

**2.1.1 OSHPD:** The applicable OSHPD Sections of the CBC are beyond the scope of this supplement.

**2.1.2 DSA:** The applicable DSA Sections of the CBC are beyond the scope of this supplement.

**2.2 CRC:**

The ETB wedge anchors, described in Sections 2.0 through 7.0 of the evaluation report [ESR-5642](#), complies with CRC Chapter 3, provided the design and installation are in accordance with the 2021 *International Residential Code*® (IRC) provisions noted in the evaluation report and the additional requirements of CRC Chapter 3.

This supplement expires concurrently with the evaluation report, reissued March 2026.

DIVISION: 04 00 00—MASONRY  
Section: 04 05 19.16—Masonry Anchors

**REPORT HOLDER:**

ALLFASTENERS USA LLC

**EVALUATION SUBJECT:**

ETB WEDGE ANCHORS IN CRACKED AND UNCRACKED GROUTED CONCRETE MASONRY UNIT WALLS

**1.0 REPORT PURPOSE AND SCOPE****Purpose:**

The purpose of this evaluation report supplement is to indicate that the ETB wedge anchors, described in ICC-ES evaluation report [ESR-5642](#), have also been evaluated for compliance with the codes noted below.

**Applicable code editions:**

- 2023 Florida Building Code—Building
- 2023 Florida Building Code—Residential

**2.0 CONCLUSIONS**

The ETB wedge anchors, described in Sections 2.0 through 7.0 of ICC-ES evaluation report [ESR-5642](#), comply with the *Florida Building Code—Building* and the *Florida Building Code—Residential*. The design requirements must be determined in accordance with the *Florida Building Code—Building* and the *Florida Building Code—Residential*, as applicable. The installation requirements noted in the ICC-ES evaluation report [ESR-5642](#) for the 2021 *International Building Code*® meet the requirements of the *Florida Building Code—Building* and the *Florida Building Code—Residential*, as applicable.

Use of the ETB wedge anchors have also been found to be in compliance with the High-Velocity Hurricane Zone provisions of the *Florida Building Code—Building* and the *Florida Building Code—Residential*, with the following conditions:

- a) Design and installation must meet the requirements of Section 2122.7 of the *Florida Building Code—Building*.
- b) For anchorage to wood members, the connection subject to uplift, must be designed for no less than 700 pounds (3114 N).

For products falling under Florida Rule 61G20-3, verification that the report holder's quality assurance program is audited by a quality assurance entity approved by the Florida Building Commission for the type of inspections being conducted is the responsibility of an approved validation entity (or the code official, when the report holder does not possess an approval by the Commission). Florida Rule 61G20-3 is applicable to products and/or systems which comprise the building envelope and structural frame for compliance with the structural requirements of the Florida Building Code.

This supplement expires concurrently with the evaluation report, reissued March 2026.