

# ETB & ETB-S2 WEDGE ANCHORS

ZINC & STAINLESS STEEL

CERTIFICATION

TECHNICAL DATA



**ICC-ESR 4346 & 5642**  
ICC-ESR Evaluated



**FOR INSTALL SUPPORT**  
[sales@allfasteners.com](mailto:sales@allfasteners.com)



**FOR SPECIFICATION SUPPORT**  
[certs@allfasteners.com](mailto:certs@allfasteners.com)



**FOR CUSTOMER SUPPORT**  
888.859.6060





# ETB & ETB-S2 WEDGE ANCHORS

ZINC &amp; STAINLESS STEEL



ICC ESR-4346 &amp; 5642

The **ETB & ETB-S2 Wedge Anchors** are a torque-controlled, wedge expansion anchor for heavy duty fastening applications where high pull out values in concrete are needed. The anchor and the hole diameter are the same, simplifying the anchor installation by placing the anchor through the existing hole in the material to be fastened. Used in fastening sheet metal, steel and aluminum angles, or wood to concrete. Due to its high resistance to vibratory loads, this anchor is ideal for installing machinery, hand rails, dock bumpers, storage racks, etc.

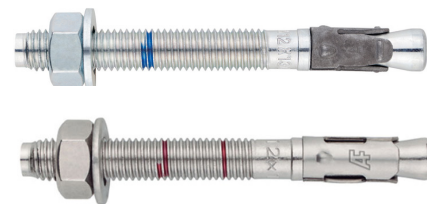

ICC ESR-4346

ICC ESR-5642

## KEY BENEFITS

- Solid Concrete (Normal-Weight and Light-Weight)
- Grout-Filled Concrete Block
- Concrete-Filled Metal Deck
- Structural Anchorage
- Machinery, Hand rail, dock bumper installation
- Storage racking anchorage
- Masonry

## ESR-4346 EVALUATION REPORT

### 1.0 RECOGNITION & CERTIFICATIONS

ICC Wedge Anchors evaluated in this report shows compliance to the following codes and regulations:

- ICC-ESR 4346
- 2021, 2018, 2015, 2012, 2009, and 2006 International Building Code® (IBC)
- 2021, 2018, 2015, 2012, 2009, and 2006 International Residential Code® (IRC)

Property Evaluated: Structural

## 2.0 USES

- The ETB Wedge Anchor is used as anchorage to resist static, wind, and seismic (Seismic Design Categories A through F) tension and shear loads in cracked and uncracked normal-weight and light weight concrete having a specified compressive strength,  $f'c$ , of 2,500 psi to 8,500 psi (17.2 MPa to 58.6 MPa).
- The ETB Wedge Anchors comply with Section 1901.3 of 2015 IBC, Section 1909 of the 2012 IBC and Section 1912 of the 2009 and 2006 IBC. The anchor system is an alternative to cast-in-place anchors described in Section 1901.3 of the 2015 IBC, Section 1908 of the 2012 IBC, and Section 1911 of the 2009 and 2006 IBC. The anchors may also be used where an engineered design is submitted in accordance with Section R301.1.3 of the IRC.

## 3.0 DESCRIPTION

### 3.1 GENERAL

ETB & ETB-S2 Wedge Anchors are torque-controlled, mechanical expansion anchors consisting of an anchor body, expansion clip, nut and washer. A typical anchor is shown in Figure 3 of this report. The anchor body has a tapered mandrel formed on the installed end of the anchor and a threaded section at the opposite end. The taper of the mandrel increases in diameter towards the installed end of the anchor. The three-segment expansion clip wraps around the tapered mandrel. Before installation, this expansion clip is free to rotate about the mandrel. The anchor is set by applying torque to the hex nut; the mandrel is drawn into the expansion clip, which engages the drilled hole and transfers the load to the base material. Pertinent dimensions are given in Table 1 and 2 of this report.



### 3.2 ETB WEDGE ANCHOR CARBON STEEL

The anchor bodies are manufactured by cold forming from carbon steel materials conforming to JIS G 3507. The zinc plating on the anchor body complies with ASTM B633 SC1 type III, with a minimum 0.0002 inch (5  $\mu$ m) thickness. The expansion clip is fabricated from low carbon steel conforming to JIS G 3141. The sherardized coating of the clips complies with EN 13811 Class 15 with a minimum 0.0006 inch (15  $\mu$ m) thickness. The hex nut for the carbon steel ETB anchor conforms to ASME B18.2.2. The washer for the carbon steel ETB anchor conforms to ASME B18.21.1. The available diameters under this report are: 1/4 inch, 3/8 inch, 1/2 inch, 5/8 inch and 3/4 inch.

### 3.3 ETB-S2 WEDGE ANCHOR STAINLESS STEEL

The anchor bodies are manufactured by machining and cold forming from stainless steel materials conforming to AISI 304 and 304HC respectively. The expansion clip is fabricated from low stainless steel conforming to AISI 304. The sherardized coating of the clips complies with EN 13811 Class 15 with a minimum 0.0006 inch (15  $\mu$ m) thickness. The hex nut for the stainless steel ETB-S2 anchor conforms to ASTM F594. The washer for the stainless steel ETB-S2 anchor conforms to ASME B18.21.1. The available diameters under this report are: 1/4 inch, 3/8 inch, 1/2 inch, 5/8 inch and 3/4 inch.

### 3.3 ETB-S2 WEDGE ANCHOR STAINLESS STEEL

Normal-weight and lightweight concrete must conform to Sections 1903 and 1905 of the IBC, as applicable.

## 4.0 DESIGN & INSTALLATION

### 4.1 STRENGTH DESIGN

**4.1.1 General:** Design strength of anchors complying with the 2021 IBC, as well as Section R301.1.3 of the 2021 IRC must be determined in accordance with ACI 318-19 Chapter 17 and this report.

Design strength of anchors complying with the 2015 IBC, as well as Section R301.1.3 of the 2015 IRC must be determined in accordance with ACI 318-14 Chapter 17 of this report.

Design strength of anchors complying with the 2012 IBC, and the 2012 IRC, must be in accordance with ACI 318-11 Appendix D and this report.

Design strength of anchors complying with the 2009 IBC, and the 2009 IRC, must be in accordance with ACI 318-08 Appendix D and this report.

Design strength of anchors complying with the 2006 IBC, and the 2006 IRC, must be in accordance with ACI 318-05 Appendix D and this report.

Design parameters are based on the 2021 IBC (ACI

318-19), 2018 and 2015 IBC (ACI 318-14) and the 2012 IBC (ACI 318-11) unless noted otherwise in Sections 4.1.1 through 4.1.12 of this report. The strength design of anchors must comply with ACI 318-19 17.5.1.2, 318-14 17.3.1 or ACI 318-11 D.4.1 as applicable, except as required in ACI 318-19 17.10, ACI 318-14 17.2.3 or ACI 318-11 D.3.3, as applicable. Strength reduction factors,  $\phi$ , as given in ACI 318-19 17.5.3, ACI 318-14 17.3.3 or ACI 318-11 D.4.3, as applicable, must be used for load combinations calculated in accordance with Section 1605.1 of the 2021 IBC or Section 1605.2 of the 2018 IBC, 2015 and 2012 IBC and Section 5.3 of ACI 318(-19 and -14) or Section 9.2 of ACI 318-11, as applicable. Strength reduction factors,  $\phi$ , as given in ACI 318-11 D.4.4 must be used for load combinations calculated in accordance with ACI 318-11 Appendix C.

The value of  $f'_c$  used in the calculations must be limited to a maximum of 8,000 psi (55.2 MPa), in accordance with ACI 318-19 17.3.1, ACI 318-14 17.2.7 or ACI 318-11 D.3.7, as applicable.

## 4.1 STRENGTH DESIGN

### 4.1.2 Requirements for Static Steel Strength in Tension, $N_{sa}$ :

The nominal static steel strength of a single anchor in tension,  $N_{sa}$ , must be calculated in accordance with ACI 318-19 17.6.1.2, ACI 318-14 17.4.1.2 or ACI 318-11 D5.1.2, as applicable. The values of  $N_{sa}$  are given in Table 3 of this report. Strength reduction factors,  $\phi$ , corresponding to ductile steel elements may be used for ETB and ETB-S2.

### 4.1.3 Requirements for Static Concrete Breakout Strength in Tension, $N_{cb}$ & $N_{cbg}$ :

The nominal static concrete breakout strength of a single anchor or group of anchors in tension,  $N_{cb}$  or  $N_{cbg}$ , must be calculated in accordance with ACI 318-19 17.6.2, ACI 318-14 17.4.2 or ACI 318-11 D.5.2, as applicable, with modifications as described in this section.

The basic concrete breakout strength of a single anchor in tension,  $N_b$ , must be calculated in accordance with ACI 318-18 17.6.2.2, ACI 318-14 17.4.2.2 or ACI 318-11 D.5.2.2, as applicable, using the selected values of  $h_{ef}$  and  $k_{cr}$  as given in Table 3 of this report. The nominal concrete breakout strength in tension, in regions where analysis indicates no cracking in accordance with ACI 318-14 17.4.2.6 or ACI 318-11 D.5.2.6, as applicable, using the values of  $h_{ef}$  and  $k_{cr}$  as given in Tables 4 and 5 of this report. The nominal concrete breakout strength in tension, in regions where analysis indicates no cracking in accordance with ACI 318-19 17.6.2.5.1, ACI 318-14 17.4.2.6 or ACI 318-11 D5.2.6, as applicable, must be calculated with  $\psi_{c,N}=1.0$  and using the value of  $k_{uncr}$  as given in Tables 4 and 5 of this report.

### 4.1.4 Requirements for Static Pullout Strength in Tension, $N_p$ :

The nominal pullout strength of a single anchor, in accordance with ACI 318-19 17.6.3.1 and 17.6.3.2.1, ACI 318-14 17.4.3.1 and 17.4.3.2 or ACI 318-11 D.5.3.1 and D.5.3.2, as applicable, in cracked and uncracked concrete,  $N_{p,cr}$  and  $N_{p,uncr}$ , respectively, is given in Tables 4 and 5 of this report. In lieu of ACI 318-19 17.6.3.3, ACI 318-14 17.4.3.6 or ACI 318-11 D.5.3.6, as applicable,  $\psi_{c,p}=1.0$  for all design cases. In accordance with ACI 318-19 17.6.3.2.1, ACI 318-14 17.4.3.2 or ACI 318-11 D.5.3.2, as applicable, the nominal pullout strength in cracked concrete must be adjusted by calculation according to the following equation.

$$N_{p,f'c} = N_{p,cr} \left( \frac{f'c}{2,500} \right)^n \quad (\text{lb, psi}) \quad (\text{Eq-1})$$

$$N_{p,f'c} = N_{p,cr} \left( \frac{f'c}{17.2} \right)^n \quad (\text{N, MPa})$$

In regions where analysis indicates no cracking in accordance with ACI 318-19 17.6.3.3, ACI 318-14 17.4.3.6 or ACI 318-11 D.5.3.6, as applicable, the nominal pullout strength in tension must be calculated according to the following equation:

$$N_{p,f'c} = N_{p,uncr} \left( \frac{f'c}{2,500} \right)^n \quad (\text{lb, psi}) \quad (\text{Eq-2})$$

$$N_{p,f'c} = N_{p,uncr} \left( \frac{f'c}{17.2} \right)^n \quad (\text{N, MPa})$$

$n$  = normalization exponent given in Tables 4 and 5.

Where values for  $N_{p,cr}$  or  $N_{p,uncr}$  are not provided in Tables 4 and 5, the pullout strength in tension need not be evaluated.

### 4.1.5 Requirements for Static Steel Strength in Shear, $V_{sa}$ :

The nominal steel strength in shear,  $V_{sa}$ , in accordance with ACI 318-19 17.7.1.2, ACI 318-14 17.5.1.2 or ACI 318-11 D.6.1.2, as applicable, is given in Tables 4 and 5 of this report and must be used in lieu of the value derived by calculation from ACI 318-19 Eq. 17.7.1.2b, ACI 318-14 Eq. 17.5.1.2b or ACI 318-11 Eq. D-29, as applicable. Strength reduction factor,  $\phi$  corresponding to ductile steel elements may be used for the ETB and ETB-S2.

### 4.1.6 Requirements for Static Concrete Breakout Strength in Shear, $V_{cb}$ or $V_{cbg}$ :

The nominal concrete breakout strength in shear of a single anchor or group of anchors in shear,  $V_{cb}$  or  $V_{cbg}$ , must be calculated in accordance with ACI 318-19 17.7.2, ACI 318-14 17.5.2 or ACI 318-11 D.6.2, as applicable, with modifications as provided in this section. The basic concrete breakout strength of a single anchor in shear,  $V_b$ , must be calculated in accordance with ACI 318-19 17.7.2.2.1, ACI 318-14 17.5.2.2 or ACI 318-11 D.6.2.2, as applicable, using values of  $l_a$  and  $d_a$  ( $d_o$ ) given in Tables 4 and 5 of this report.

### 4.1.7 Requirements for Static Concrete Pryout Strength in Shear, $V_{cp}$ or $V_{cpg}$ :

The nominal static concrete pryout strength of a single anchor or group of anchors in shear,  $V_{cp}$  or  $V_{cpg}$ , must be calculated in accordance with ACI 318-19 17.7.3, ACI 318-14 17.5.3 or ACI 318-11 D.6.3, as applicable, modified by using the value of  $k_{cp}$  provided in Tables 4 and 5 of this report and the value of  $N_{cb}$  or  $N_{cbg}$  as calculated in accordance with Section 4.1.3 of this report.



## 4.1 STRENGTH DESIGN

### 4.1.8 Requirements for Seismic Design:

**4.1.8.1 General:** For load combinations including seismic, the design must be performed in accordance with ACI 318-19 17.10, ACI 318-14 17.2.3 or ACI 318-11 D.3.3, as applicable. Modifications to ACI 318-19 17.10 shall be applied under Section 1905.1.8 of the 2021 IBC. Modifications to ACI 318-14 17.2.3 shall be applied under Section 1905.1.8 of the 2018 and 2015 IBC. For the 2012 IBC, Section 1905.1.9 shall be omitted. Modifications to ACI 318 (-08, -05) D3.3 shall be applied under Section 1908.1.9 of the 2009 IBC, or Section 1908.1.16 of the 2006 IBC as applicable.

**4.1.8.2 Seismic Tension:** The nominal steel strength and the nominal concrete breakout strength for anchors in tension must be calculated according to ACI 318-19 17.6.1 and 17.6.2, ACI 318-14 17.4.1 and 17.4.2 or ACI 318-11 D.5.1 and D.5.2, respectively, as described in Sections 4.1.2 and 4.1.3 of this report. In accordance with ACI 318-14 17.4.3.2 or ACI 318-11 D.5.3.2, as applicable, the appropriate pullout strength in tension for seismic loads,  $N_{p,eq}$  may be adjusted by calculation for concrete strength in accordance with Eq-1 and Section 4.1.4 whereby the value of  $N_{p,eq}$  must be substituted for  $N_{p,cr}$ . If no values for  $N_{p,eq}$  are given in Tables 4 and 5, the static design values govern.

**4.1.8.3 Seismic Shear:** The nominal breakout strength and pryout strength for anchors in shear must be calculated according to ACI 318-19 17.7.2 and 17.7.3, ACI 318-14 17.5.2 and 17.5.3 or ACI 318-11 D.6.2 and D.6.3, respectively, as described in Sections 4.1.6 and 4.1.7 of this report. In accordance with ACI 318-19 17.7.1.2, ACI 318-14 17.5.1.2 or ACI 318-11 D.6.1.2 the appropriate value for nominal steel strength for seismic loads,  $V_{sa,eq}$  described in Tables 4 and 5 must be used in lieu of  $V_{sa}$ .

### 4.1.9 Requirements for Interaction of Tensile and Shear

**Forces:** For anchors or groups of anchors that are subject to the effects of combined tensile and shear forces, the design must be performed in accordance with ACI 318-19 17.8, ACI 318-14 17.6 or ACI 318-11 D.7, as applicable.

**4.1.10 Requirements for Critical Edge Distance:** In applications where  $c < c_{ac}$  and supplemental reinforcement to control splitting of the concrete is not present, the concrete breakout strength in tension for uncracked concrete, calculated according to ACI 318-19 17.6.2, ACI 318-14 17.4.2 or ACI 318-11 D.5.2, as applicable, must further be multiplied by

factor  $\psi_{cp,N}$  as given by the following equation:

$$\psi_{cp,N} = \frac{c}{c_{ac}} \tag{Eq-3}$$

Where the factor  $\psi_{cp,N}$  need not be taken as less than  $1.5h_{ef} / c_{ac}$ . For all other cases,  $\psi_{cp,N} = 1.0$ . In lieu of ACI 318-19 17.9.5, ACI 318-14 17.7.6 or ACI 318-11 D.8.6, as applicable, values for the critical edge distance  $c_{ac}$  must be taken from Tables 1 and 2 of this report.

### 4.1.11 Requirements for Minimum Member Thickness, Anchor Spacing and Edge Distance:

In lieu of ACI 318-19 17.9.2, ACI 318-14 17.7.1 and 17.7.3 or ACI 318-11 D.8.1 and D.8.3, respectively, values of  $s_{min}$  and  $c_{min}$  as given in Tables 1 and 2 must be used. In lieu of ACI 318-19 17.9.4, ACI 318-14 17.7.5 or ACI 318-11 D.8.5, as applicable, minimum member thickness  $h_{min}$  as given in Tables 1 and 2 must be used. Additional combinations for minimum edge distance  $c_{min}$  and spacing  $s_{min}$  may be derived by linear interpolation between the given boundary values as show in the following figures.

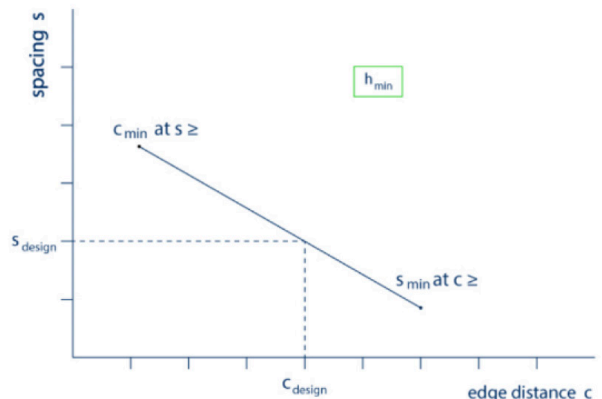
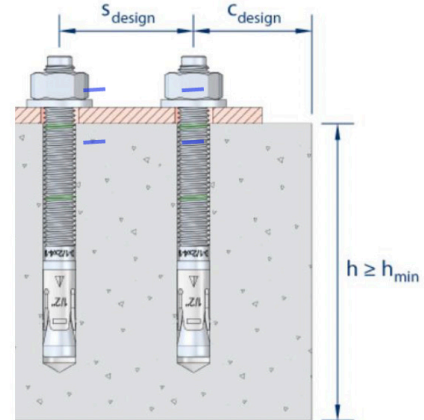



## 4.1 STRENGTH DESIGN

**4.1.12 Lightweight Concrete:** For the use of anchors in lightweight concrete, the modification factor  $\lambda_a$  equal to  $0.8\lambda$  is applied to all values of  $\sqrt{f'_c}$ , affecting  $N_n$  and  $V_n$ .

For ACI 318-19 (2021 IBC), ACI 318-14 (2018 and 2015 IBC), AI 318-11 (2012 IBC) and ACI318-08 (2009 IBC),  $\lambda$  shall be determined in accordance with the corresponding version of ACI 318.

For ACI 318-05 (2006 IBC),  $\lambda$  shall be taken as 0.75 for all lightweight concrete and 0.85 for sand-lightweight concrete. Linear interpolation shall be permitted if partial sand replacement is used. In addition, the pullout strengths  $N_{p,uncr}$ ,  $N_{p,cr}$  and  $N_{p,eq}$  shall be multiplied by the modification factor,  $\lambda_a$ , as applicable.

## 4.2 ALLOWABLE STRESS DESIGN (ASD)

**4.2.1 General:** Design values for use with allowable stress design load combinations calculated in accordance with Section 1605.3 of the IBC shall be established as follows:

$$T_{allowable,ASD} = \frac{\phi N_n}{\alpha} \quad (\text{Eq-4})$$

$$V_{allowable,ASD} = \frac{\phi V_n}{\alpha} \quad (\text{Eq-5})$$

Where

$T_{allowable,ASD}$  = Allowable tension load (lbf or kN)

$V_{allowable,ASD}$  = Allowable shear load (lbf or kN)

$\phi N_n$  = The lowest design strength of an anchor or anchor group in tension as determined in accordance with ACI 318 (-19 and -14) Chapter 17 and 2021, 2018 and 2015 IBC Section 1905.1.8; ACI 318-11 Appendix D, ACI 318-08 Appendix D and 2009 IBC Section 1908.1.9, ACI 318-05 Appendix D and 2006 IBC Section 1908.1.16, and Section 4.1 of this report, as applicable. For the 2012 IBC, Section 1905.1.9 shall be omitted.

$\phi V_n$  = The lowest design strength of an anchor or anchor group in shear as determined in accordance with ACI 318 (-19 and -14) Chapter 17 and 2021, 2018 and 2015 IBC Section 1905.1.8; ACI 318-11 Appendix D; ACI 318-08 Appendix D and 2009 IBC Section 1908.1.9; ACI 318-05 Appendix D and 2006 IBC Section 1908.1.16, and Section

4.1 of this report, as applicable. For the 2012 IBC, Section 1905.1.9 shall be omitted.

$\alpha$  = Conversion factor calculated as a weighted average of the load factors for the controlling load combination. In addition,  $\alpha$  shall include all appropriate factors to account for nonductile failure modes and required over-strength.

The requirements for member thickness, edge distance and spacing, as described in this report, must apply. An example of allowable stress design values for illustrative purposes is shown Table 6.

### 4.2.2 Requirements for Interaction of Tensile and Shear

**Forces:** The interaction must be calculated and consistent with ACI 318-19 17.8, ACI 318-14 17.6 or ACI 318 (-11, -08, -05) D.7, as applicable, as follows:

For tension loads  $T_{applied} \leq 0.2T_{allowable,ASD}$ , the full allowable strength in shear,  $V_{allowable,ASD}$ , may be taken.

For shear loads  $V_{applied} \leq 0.2V_{allowable,ASD}$ , the full allowable load in tension,  $T_{allowable,ASD}$ , may be taken.

For all other cases:

$$\frac{T_{applied}}{T_{allowable,ASD}} + \frac{V_{applied}}{V_{allowable,ASD}} \leq 1.2 \quad (\text{Eq-6})$$



## 4.3 INSTALLATION

Installation parameters are provided in Tables 1 and 2 and Figures 1 and 2. Anchors must be installed per the manufacturer's published instructions and this report. Anchor locations must comply with this report and the plans and specifications approved by the code official. Anchors must be installed in holes drilled into concrete using carbide-tipped drill bits complying with ANSI B212.15-1994. The nominal drill diameter must be equal to the nominal diameter of the anchor. Prior to anchor installation, the hole must be cleaned in accordance with the manufacturer's published installation instructions. The anchor must be hammered into the predrilled hole until the embedment depth ring mark flushes with the concrete surface. The nut must be tightened against the washer until the torque value,  $T_{inst}$ , specified in Tables 1 and 2, is achieved.

## 4.4 SPECIAL INSPECTION

Periodic special inspection is required, in accordance with Section 1705.1.1 and Table 1705.3 of the 2021, 2018, 2015 or 2021 IBC; Section 1704.15 and Table 1704.4 of the 2009 IBC; or Section 1704.13 of the 2006 IBC, as applicable. The special inspector must make periodic inspections during anchor installation to verify anchor type, anchor dimensions, concrete type, concrete compressive strength, hole dimensions, anchor spacing, edge distances, concrete thickness, anchor embedment, installation torque, and adherence to the manufacturer's published installation instructions. The special inspector must be present as often as required in accordance with the "statement of special inspection". Under the IBC, additional requirements as set forth in Sections 1705, 1706 and 1707 must be observed, where applicable.

## 5.0 CONDITIONS OF USE

The ETB and ETB-S2 Wedge Anchors described in this report complies with, or is a suitable alternative to what is specified in, those codes listed in Section 1.0 of this report, subject to the following conditions:

- |   |   |
|---|---|
| <p><b>5.1</b> Anchor sizes, dimensions and minimum embedment depths are as set forth in the tables of this report.</p> <p><b>5.2</b> The 1/4-inch diameter anchors must be installed in accordance with the manufacturer's published installation instructions in this report, in uncracked normal-weight and light-weight concrete having a specified compressive strength of <math>f'_c = 2,500</math> psi to 8,500 psi (17.2 MPa to 58.6 MPa).</p> <p><b>5.3</b> The 3/8-inch through 3/4-inch diameter anchors must be installed in accordance with the manufacturer's published installation instructions in this report, in cracked and uncracked normal-weight and lightweight concrete having a specified compressive strength of <math>f'_c = 2,500</math> psi to 8,500 psi (17.2 MPa to 58.6 MPa).</p> <p><b>5.4</b> The values of <math>f'_c</math> used for calculation purposes must not exceed 8,000 psi (55.1 MPa).</p> <p><b>5.5</b> The concrete shall have attained its minimum design strength prior to installation of the anchors.</p> <p><b>5.6</b> Strength design values are established in accordance with Section 4.1 of this report.</p> <p><b>5.7</b> Allowable stress design values are established in accordance with Section 4.2 of this report.</p> | <p><b>5.8</b> Anchor spacing and edge distance as well as minimum member thickness must comply with Tables 1 and 2 of this report.</p> <p><b>5.9</b> Prior to installation, calculations and details demonstrating compliance with this report must be submitted to the code official. The calculations and details must be prepared by a registered design professional where required by the statutes of the jurisdiction in which the project is to be constructed.</p> <p><b>5.10</b> Since an ICC-ES acceptance criteria for evaluating data to determine the performance of anchors subjected to fatigue or shock load is unavailable at this time, the use of these anchors under such conditions is beyond the scope of this report.</p> <p><b>5.11</b> Anchors, with the exception of 1/4-inch diameter anchor, may be installed in regions of concrete where cracking has occurred or where analysis indicates cracking may occur (<math>f_t &gt; f_r</math>), subject to the conditions of the report.</p> <p><b>5.12</b> The 1/4-inch diameter anchors may be used to resist short-term loading due to wind or seismic forces in locations designated as Seismic Design Categories A and B under the IBC, subject to the conditions of this report.</p> |
|---|---|



## 5.0 CONDITIONS OF USE

- 5.13** The 3/8-inch through 3/4-inch anchors may be used to resist short-term loading due to wind or seismic forces in locations designated as Seismic Design Categories A through F under the IBC, subject to the conditions of this report.
- 5.14** Where not otherwise prohibited in the code, anchors are permitted for use with fire-resistance-rated construction provided that at least one of the following conditions is fulfilled:
- Anchors are used to resist wind or seismic forces only.
  - Anchors that support a fire-resistance-rated envelope or fire-resistance-rated membrane, are protected by approved fire-resistance-rated materials, or have been evaluated for resistance to fire exposure in accordance with recognized standards.
- Anchors are used to support nonstructural elements.
- 5.15** Use of zinc-coated carbon steel anchors is limited to dry, interior locations.
- 5.16** Use of anchors made of stainless steel as specified in this report are permitted for exterior exposure and damp environments.
- 5.17** Use of anchors made of stainless steel as specified in this report are permitted for contact with preservative-treated and fire-retardant-treated wood.
- 5.18** Special inspection must be provided in accordance with Section 4.4 of this report.
- 5.19** Anchors are manufactured under an approved quality control program with inspections by ICC-ES.

## 6.0 EVIDENCE SUBMITTED

Data in accordance with the ICC-ES Acceptance Criteria for Mechanical Anchors in Concrete Elements (AC193), dated October 2017 (editorially revised December 2020), which incorporates requirements in ACI 355.2-19 and ACI 355.2-07, for use in cracked and uncracked concrete; and quality control document

## 7.0 IDENTIFICATION

The anchors are identified by packaging labeled with the evaluation report holder's name (Allfasteners USA LLC) and address, anchor name, anchor diameter size, anchor length and evaluation report number (ESR-4346). The anchors have the letters ETB and ETB-S2 and the anchor diameter size embossed on the sleeve.



# ETB & ETB-S2 WEDGE ANCHORS

ZINC & STAINLESS STEEL



## INSTALLATION PARAMETERS

**TABLE 1: ETB ANCHOR INSTALLATION PARAMETERS<sup>1</sup>**

CHARACTERISTIC	SYMBOL	UNITS	NOMINAL ANCHOR DIAMETER							
			1/4"	3/8"	1/2"		5/8"		3/4"	
Outside Diameter	$d_o^2$	in (mm)	1/4 (6.4)	3/8 (9.5)	1/2 (12.7)	1/2 (12.7)	5/8 (15.9)	5/8 (15.9)	3/4 (19.1)	3/4 (19.1)
Nominal Embedment Depth	$h_{nom}$	in (mm)	1.68 (43)	2.33 (59)	2.33 (59)	3.59 (91)	3.23 (82)	4.49 (114)	3.74 (95)	5.26 (134)
Effective Embedment Depth	$h_{ef}$	in (mm)	1-1/2 (38)	2 (51)	2 (51)	3-1/4 (83)	2-3/4 (70)	4 (102)	3-1/4 (83)	4-3/4 (121)
Minimum Hole Depth	$h_{hole}$	in (mm)	2 (51)	2-5/8 (67)	2-5/8 (67)	4 (102)	3-1/2 (89)	4-3/4 (121)	4 (102)	5-3/4 (146)
Clearance Hole Diameter	$d_r$	in (mm)	5/16 (7.9)	7/16 (11.1)	9/16 (14.3)		11/16 (17.5)		7/8 (22.2)	
Recommended Installation Torque	$T_{inst}$	ft.lb (Nm)	5 (7)	30 (41)	45 (61)		75 (102)		150 (203)	
Minimum Concrete Thickness	$h_{min}$	in (mm)	4 (102)	4 (102)	4 (102)	6 (152)	5-1/2 (140)	6-1/2 (165)	6 (152)	8 (203)
Criteria Edge Distance	$c_{ac}$	in (mm)	2-3/4 (70)	6 (152)	6 (152)	7-1/2 (191)	7 (178)	8-1/2 (216)	9 (229)	12 (305)
Minimum Edge Distance ( $c_{min}$ ) for Spacing ( $s \geq$ )	$c_{min}$	in (mm)	1-3/4 (44)	2-1/2 (64)	3 (76)	2-1/2 (64)	3-1/2 (89)	3-1/2 (89)	5 (127)	4-1/2 (114)
	$s \geq$	in (mm)	2-1/4 (57)	6-1/2 (165)	6 (152)	6 (152)	8 (203)	6 (152)	10-1/2 (267)	9-1/2 (241)
Minimum Spacing ( $s_{min}$ ) for Edge Distance ( $c \geq$ )	$s_{min}$	in (mm)	2-1/4 (57)	2-1/2 (64)	2-3/4 (70)	2-1/2 (64)	4-1/2 (114)	4 (102)	5 (127)	4 (102)
	$c \geq$	in (mm)	1-3/4 (44)	4 (102)	6 (152)	4 (102)	6 (152)	5 (127)	10-1/2 (267)	8-1/2 (216)
Minimum Overall Anchor Length	$l_{anch}$	in (mm)	2-1/4 (57)	3 (76)	3-1/2 (89)	4-1/2 (114)	4-1/4 (108)	5-1/2 (140)	5 (127)	6-1/2 (165)
Torque Wrench Socket Size	-	in	7/16	9/16	3/4		15/16		1-1/8	

- The tabulated data is to be used in conjunction with the design criteria given in ACI 318 (-19 and -14) Chapter 17 or ACI 318-11 Appendix D.
- For the 2006 IBC:  $d_o$  replaces  $d_a$  and  $A_{se,N}$  replaces  $A_{se}$ .

**TABLE 2: ETB-S2 ANCHOR INSTALLATION PARAMETERS<sup>1</sup>**

CHARACTERISTIC	SYMBOL	UNITS	NOMINAL ANCHOR DIAMETER							
			1/4"	3/8"	1/2"		5/8"		3/4"	
Outside Diameter	$d_o^2$	in (mm)	1/4 (6.4)	3/8 (9.5)	1/2 (12.7)	1/2 (12.7)	5/8 (15.9)	5/8 (15.9)	3/4 (19.1)	3/4 (19.1)
Nominal Embedment Depth	$h_{nom}$	in (mm)	1.68 (43)	2.33 (59)	2.33 (59)	3.59 (91)	3.23 (82)	4.49 (114)	3.74 (95)	5.26 (134)
Effective Embedment Depth	$h_{ef}$	in (mm)	1-1/2 (38)	2 (51)	2 (51)	3-1/4 (83)	2-3/4 (70)	4 (102)	3-1/4 (83)	4-3/4 (121)
Minimum Hole Depth	$h_{hole}$	in (mm)	2 (51)	2-5/8 (67)	2-5/8 (67)	4 (102)	3-1/2 (89)	4-3/4 (121)	4 (102)	5-3/4 (146)
Clearance Hole Diameter	$d_r$	in (mm)	5/16 (7.9)	7/16 (11.1)	9/16 (14.3)		11/16 (17.5)		7/8 (22.2)	
Recommended Installation Torque	$T_{inst}$	ft.lb (Nm)	5 (7)	20 (27)	45 (61)		80 (108)		150 (203)	
Minimum Concrete Thickness	$h_{min}$	in (mm)	4 (102)	4 (102)	4 (102)	6 (152)	5-1/2 (140)	6-1/2 (165)	6 (152)	8 (203)
Criteria Edge Distance	$c_{ac}$	in (mm)	3 (76)	6-1/2 (165)	6-1/2 (165)	7-1/2 (191)	7 (178)	8-1/2 (216)	9 (229)	12 (305)
Minimum Edge Distance ( $c_{min}$ ) for Spacing ( $s \geq$ )	$c_{min}$	in (mm)	1-3/4 (44)	2-1/2 (64)	3 (76)	2-1/2 (64)	3-1/2 (89)	3-1/2 (89)	5 (127)	4-1/2 (114)
	$s \geq$	in (mm)	2-1/4 (57)	6-1/2 (165)	6 (152)	6 (152)	8 (203)	6 (152)	10-1/2 (267)	9-1/2 (241)
Minimum Spacing ( $s_{min}$ ) for Edge Distance ( $c \geq$ )	$s_{min}$	in (mm)	2-1/4 (57)	2-1/2 (64)	2-3/4 (70)	2-1/2 (64)	4-1/2 (114)	4 (102)	5 (127)	4 (102)
	$c \geq$	in (mm)	1-3/4 (44)	4 (102)	6 (152)	4 (102)	6 (152)	5 (127)	10-1/2 (267)	8-1/2 (216)
Minimum Overall Anchor Length	$l_{anch}$	in (mm)	2-1/4 (57)	3 (76)	3-1/2 (89)	4-1/2 (114)	4-1/4 (108)	5-1/2 (140)	5 (127)	6-1/2 (165)
Torque Wrench Socket Size	-	in	7/16	9/16	3/4		15/16		1-1/8	

- The tabulated data is to be used in conjunction with the design criteria given in ACI 318 (-19 and -14) Chapter 17 or ACI 318-11 Appendix D.
- For the 2006 IBC:  $d_o$  replaces  $d_a$  and  $A_{se,N}$  replaces  $A_{se}$ .



**INSTALLATION PARAMETERS**

**TABLE 3: ETB AND ETB-S2 WEDGE ANCHOR LENGTH CODE IDENTIFICATION SYSTEM**

	A	B	C	D	E	F	G	H	I	J	K	L	M	N	O	P	Q
Mark From	1-1/2"	2"	2-1/2"	3"	3-1/2"	4"	4-1/2"	5"	5-1/2"	6"	6-1/2"	7"	7-1/2"	8"	8-1/2"	9"	9-1/2"
Up to*	2"	2-1/2"	3"	3-1/2"	4"	4-1/2"	5"	5-1/2"	6"	6-1/2"	7"	7-1/2"	8"	8-1/2"	9"	9-1/2"	10"

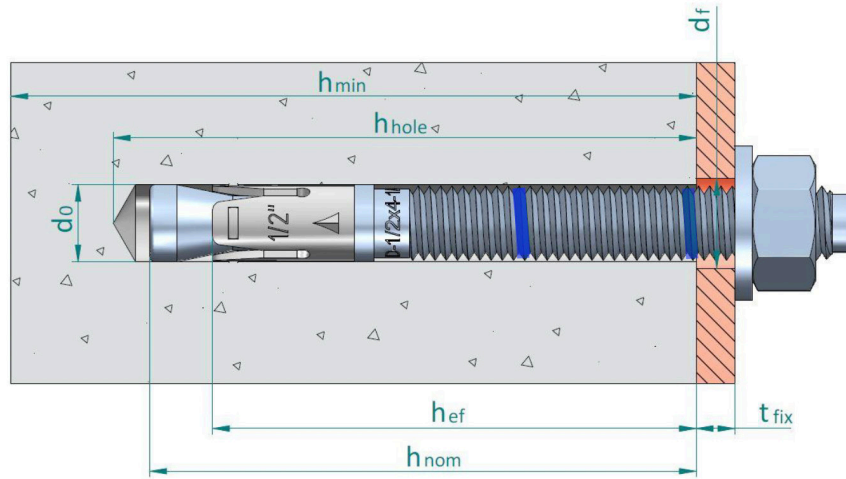

**FIGURE 1—ANCHOR DIMENSIONS**

**TABLE 4: ETB ANCHOR DESIGN INFORMATION<sup>1,3,4,5</sup>**

CHARACTERISTIC	SYMBOL	UNITS	NOMINAL ANCHOR DIAMETER							
			1/4"	3/8"	1/2"	5/8"	3/4"	3/4"	3/4"	3/4"
Outside Diameter	$d_o^2$	in (mm)	1/4 (6.4)	3/8 (9.5)	1/2 (12.7)	1/2 (12.7)	5/8 (15.9)	5/8 (15.9)	3/4 (19.1)	3/4 (19.1)
Nominal Embedment Depth	$h_{nom}$	in (mm)	1.68 (43)	2.33 (59)	2.33 (59)	3.59 (91)	3.23 (82)	4.49 (114)	3.74 (95)	5.26 (134)
Effective Embedment Depth	$h_{ef}$	in (mm)	1-1/2 (38)	2 (51)	2 (51)	3-1/4 (83)	2-3/4 (70)	4 (102)	3-1/4 (83)	4-3/4 (121)
Effective Steel Stress Area (Threads)	$A_{se}^2$	in <sup>2</sup> (mm <sup>2</sup> )	0.0318 (20.5)	0.077 (49.7)	0.141 (91.0)	0.141 (91.0)	0.226 (145.8)	0.226 (145.8)	0.334 (215.5)	0.334 (215.5)
Effective Steel Stress Area (Neck)	$A_{se}^2$	in <sup>2</sup> (mm <sup>2</sup> )	0.023 (14.8)	0.0562 (36.3)	0.100 (64.5)	0.100 (64.5)	0.160 (103.2)	0.160 (103.2)	0.238 (153.5)	0.238 (153.5)

For SI: 1 inch = 25.4mm, 1lbf = 4.45N, 1 lb/in = 0.175 N/mm, 1 psi = 0.00689 MPa = 0.00689 N/mm<sup>2</sup>, 1 in<sup>2</sup> = 645 mm<sup>2</sup>

- The tabulated data is to be used in conjunction with the design criteria given in ACI 318 (-19 and -14) Chapter 17 or ACI 318-11 Appendix D.
- For the 2006 IBC:  $d_o$  replaces  $d_a$  and  $A_{se,N}$  replaces  $A_{se}$ .
- The strength reduction factors apply when the load combinations of Section 1605.1 of the 2021 INC or Section 1605.2 of the 2018, 2015, 2012, 2009 and 2006 IBC, ACI 318 (-19 and -14) Section 5.3 or ACI 318-11 Section 9.2 are used, and the requirements of ACI 318-19 17.5.3, ACI 318-14 17.3.3(c) or ACI 318-11 D.4.3(c), as applicable, for Condition B (supplementary reinforcement not present) are met. For installations where complying reinforcement can be verified, the applicable strength reduction factors described in ACI 318-19 17.5.3, ACI 318-14 17.3.3(c) or ACI 318-11 D.4.3(c), as applicable, may be used for Condition A (supplementary reinforcement present). If the load combinations of ACI 318-11 Appendix C are used, the appropriate strength reduction factor must be determined in accordance with ACI 318-11 D4.4(a) or D.4.4(c) for Condition B (supplementary reinforcement no present), as applicable.
- Where no value is reported for pullout strength, this resistance does not need to be considered.
- N/A = Not Applicable.



**INSTALLATION PARAMETERS**

**TABLE 4: ETB ANCHOR DESIGN INFORMATION<sup>1,3,4,5</sup> CONTINUED**

CHARACTERISTIC	SYMBOL	UNITS	NOMINAL ANCHOR DIAMETER								
			1/4"	3/8"	1/2"	5/8"	3/4"				
<b>STEEL STRENGTH IN TENSION AND SHEAR</b>											
Minimum Specified Yield Strength (Threads)	$f_y$	psi (N/mm <sup>2</sup> )	69,500 (480)								
Minimum Specified Yield Strength (Neck)	$f_y$	psi (N/mm <sup>2</sup> )	90,500 (624)	85,000 (585)				81,000 (560)		77,000 (530)	
Minimum Specified Ultimate Strength	$f_{ut}$	psi (N/mm <sup>2</sup> )	87,000 (600)								
Steel Strength in Tension	$N_{sa}$	lb(kN)	2,599 (11.6)	6,125 (27.2)	10,600 (47.2)	10,600 (47.2)	16,240 (72.2)	16,240 (72.2)	22,730 (101.1)	22,730 (101.1)	
Strength Reduction Factor for Tension Steel Failure	$\phi_{sa}$	-	0.75								
Steel Strength in Shear	$V_{sa}$	lb(kN)	974 (4.33)	2,860 (12.7)	4,820 (21.4)	4,820 (21.4)	9,040 (40.2)	9,040 (40.2)	12,300 (54.7)	14,280 (63.5)	
Steel Strength in Shear, Seismic	$V_{sa,eq}$	lb(kN)	N/A	2,720 (12.1)	4,045 (17.9)	4,045 (17.9)	7,700 (34.2)	7,700 (34.2)	8,870 (39.4)	8,870 (39.4)	
Strength Reduction Factor for Steel Failure in Shear	$\phi_{sa}$	-	0.65								
<b>PULLOUT STRENGTH IN TENSION</b>											
Pullout Strength in Uncracked Concrete	$N_{p,uncr}$	lb(kN)	1,575 (7.01)	3,325 (14.79)	3,394 (15.10)	5,723 (25.46)	-	-	-	-	
Pullout Strength in Cracked Concrete	$N_{p,cr}$	lb(kN)	N/A	2,163 (9.62)	-	4,252 (18.91)	-	-	-	-	
Pullout Strength in Cracked Concrete, Seismic	$N_{eq}$	lb(kN)	N/A	2,115 (9.41)	-	4,252 (18.91)	-	-	-	-	
Anchor Category	1,2 or 3	-	1	1	1	1	1	1	1	1	
Strength Reduction Factor for Pullout Strength in Tension	$\phi_p$	-	0.65								
<b>CONCRETE BREAKOUT STRENGTH IN TENSION</b>											
Effectiveness Factor for Uncracked Concrete	$k_{uncr}$	-	24	24	24	24	24	24	27	24	
Effectiveness Factor for Cracked Concrete	$k_{cr}$	-	-	17	17	17	21	17	21	21	
Strength Reduction Factor for Concrete Breakout Strength in Tension	$\phi_{cb}$	-	0.65								
Axial Stiffness in Service Load Range in Uncracked Concrete	$\beta_{uncr}$	lb/in (N/mm)	162,300 (28,424)	169,540 (29,690)	296,770 (51,972)	129,020 (22,594)	134,210 (23,503)	88,970 (15,580)	165,900 (29,053)	138,430 (24,242)	
Axial Stiffness in Service Load Range in Cracked Concrete	$\beta_{cr}$	lb/in (N/mm)	N/A	74,240 (13,001)	76,285 (13,359)	52,680 (9,225)	48,940 (8,570)	61,430 (10,758)	75,610 (13,241)	90,400 (15,830)	
Normalization Exponent, Uncracked Concrete	$n$	-	0.32	0.38	0.39	0.50	0.50	0.50	0.50	0.50	
Normalization Exponent, Cracked Concrete	$n$	-	N/A	0.50	0.50	0.46	0.50	0.50	0.50	0.50	

For SI: 1 inch = 25.4mm, 1lbf = 4.45N, 1 lb/in = 0.175 N/mm, 1 psi = 0.00689 MPa = 0.00689 N/mm<sup>2</sup>, 1 in<sup>2</sup> = 645 mm<sup>2</sup>

- The tabulated data is to be used in conjunction with the design criteria given in ACI 318 (-19 and -14) Chapter 17 or ACI 318-11 Appendix D.
- For the 2006 IBC:  $d_c$  replaces  $d_n$  and  $A_{sa,N}$  replaces  $A_{sa}$ .
- The strength reduction factors apply when the load combinations of Section 1605.1 of the 2021 INC or Section 1605.2 of the 2018, 2015, 2012, 2009 and 2006 IBC, ACI 318 (-19 and -14) Section 5.3 or ACI 318-11 Section 9.2 are used, and the requirements of ACI 318-19 17.5.3, ACI 318-14 17.3.3(c) or ACI 318-11 D.4.3(c), as applicable, for Condition B (supplementary reinforcement not present) are met. For installations where complying reinforcement can be verified, the applicable strength reduction factors described in ACI 318-19 17.5.3, ACI 318-14 17.3.3(c) or ACI 318-11 D.4.3(c), as applicable, may be used for Condition A (supplementary reinforcement present). If the load combinations of ACI 318-11 Appendix C are used, the appropriate strength reduction factor must be determined in accordance with ACI 318-11 D.4.4(a) or D.4.4(c) for Condition B (supplementary reinforcement no present), as applicable.
- Where no value is reported for pullout strength, this resistance does not need to be considered.
- N/A = Not Applicable.



# ETB & ETB-S2 WEDGE ANCHORS

ZINC & STAINLESS STEEL



## INSTALLATION PARAMETERS

**TABLE 4: ETB ANCHOR DESIGN INFORMATION<sup>1,3,4,5</sup> CONTINUED**

CHARACTERISTIC	SYMBOL	UNITS	NOMINAL ANCHOR DIAMETER							
			1/4"	3/8"	1/2"		5/8"		3/4"	
<b>CONCRETE BREAKOUT STRENGTH IN SHEAR</b>										
Nominal Diameter	$d_o^2$	in (mm)	1/4 (6.4)	3/8 (9.5)	1/2 (12.7)	1/2 (12.7)	5/8 (15.9)	5/8 (15.9)	3/4 (19.1)	3/4 (19.1)
Load Bearing Length of Anchor	$l_e$	in (mm)	1-1/2 (3.8)	2 (51)	2 (51)	3-1/4 (83)	2-3/4 (70)	4 (102)	3-1/4 (83)	4-3/4 (121)
Reduction Factor for Concrete Breakout Strength in Shear	$\phi_{cb}$	-	0.70							
<b>CONCRETE PRYOUT STRENGTH IN SHEAR</b>										
Coefficient for Pryout Strength	$k_{cp}$	-	1.0	1.0	2.0	2.0	2.0	2.0	2.0	2.0
Reduction Factor for Pryout Strength in Shear	$\phi_{cp}$	-	0.70							

For SI: 1 inch = 25.4mm, 1lbf = 4.45N, 1 lb/in = 0.175 N/mm, 1 psi = 0,00689 MPa = 0.00689 N/mm<sup>2</sup>, 1 in<sup>2</sup> = 645 mm<sup>2</sup>

- The tabulated data is to be used in conjunction with the design criteria given in ACI 318 (-19 and -14) Chapter 17 or ACI 318-11 Appendix D.
- For the 2006 IBC:  $d_o$  replaces  $d_a$  and  $A_{se,N}$  replaces  $A_{se}$ .
- The strength reduction factors apply when the load combinations of Section 1605.1 of the 2021 INC or Section 1605.2 of the 2018, 2015, 2012, 2009 and 2006 IBC, ACI 318 (-19 and -14) Section 5.3 or ACI 318-11 Section 9.2 are used, and the requirements of ACI 318-19 17.5.3, ACI 318-14 17.3.3(c) or ACI 318-11 D.4.3(c), as applicable, for Condition B (supplementary reinforcement not present) are met. For installations where complying reinforcement can be verified, the applicable strength reduction factors described in ACI 318-19 17.5.3, ACI 318-14 17.3.3(c) or ACI 318-11 D.4.3(c), as applicable, may be used for Condition A (supplementary reinforcement present). If the load combinations of ACI 318-11 Appendix C are used, the appropriate strength reduction factor must be determined in accordance with ACI 318-11 D4.4(a) or D.4.4(c) for Condition B (supplementary reinforcement no present), as applicable.
- Where no value is reported for pullout strength, this resistance does not need to be considered.
- N/A = Not Applicable.

**TABLE 5: ETB-S2 ANCHOR DESIGN INFORMATION<sup>1,3,4,5</sup>**

CHARACTERISTIC	SYMBOL	UNITS	NOMINAL ANCHOR DIAMETER							
			1/4"	3/8"	1/2"		5/8"		3/4"	
Outside Diameter	$d_o^2$	in (mm)	1/4 (6.4)	3/8 (9.5)	1/2 (12.7)	1/2 (12.7)	5/8 (15.9)	5/8 (15.9)	3/4 (19.1)	3/4 (19.1)
Nominal Embedment Depth	$h_{nom}$	in (mm)	1.68 (43)	2.33 (59)	2.33 (59)	3.59 (91)	3.23 (82)	4.49 (114)	3.74 (95)	5.26 (134)
Effective Embedment Depth	$h_{ef}$	in (mm)	1-1/2 (38)	2 (51)	2 (51)	3-1/4 (83)	2-3/4 (70)	4 (102)	3-1/4(83)	4-3/4 (121)
Effective Steel Stress Area (Threads)	$A_{se}^2$	in <sup>2</sup> (mm <sup>2</sup> )	0.0318 (20.5)	0.077 (49.7)	0.141 (91.0)	0.141 (91.0)	0.226 (145.8)	0.226 (145.8)	0.334 (215.5)	0.334 (215.5)
Effective Steel Stress Area (Neck)	$A_{se}^2$	in <sup>2</sup> (mm <sup>2</sup> )	0.023 (14.8)	0.061 (39.6)	0.112 (72.4)	0.112 (72.4)	0.164 (105.7)	0.164 (105.7)	0.239 (153.9)	0.239 (153.9)

For SI: 1 inch = 25.4mm, 1lbf = 4.45N, 1 lb/in = 0.175 N/mm, 1 psi = 0,00689 MPa = 0.00689 N/mm<sup>2</sup>, 1 in<sup>2</sup> = 645 mm<sup>2</sup>

- The tabulated data is to be used in conjunction with the design criteria given in ACI 318 (-19 and -14) Chapter 17 or ACI 318-11 Appendix D.
- For the 2006 IBC:  $d_o$  replaces  $d_a$  and  $A_{se,N}$  replaces  $A_{se}$ .
- The strength reduction factors apply when the load combinations of Section 1605.1 of the 2021 INC or Section 1605.2 of the 2018, 2015, 2012, 2009 and 2006 IBC, ACI 318 (-19 and -14) Section 5.3 or ACI 318-11 Section 9.2 are used, and the requirements of ACI 318-19 17.5.3, ACI 318-14 17.3.3(c) or ACI 318-11 D.4.3(c), as applicable, for Condition B (supplementary reinforcement not present) are met. For installations where complying reinforcement can be verified, the applicable strength reduction factors described in ACI 318-19 17.5.3, ACI 318-14 17.3.3(c) or ACI 318-11 D.4.3(c), as applicable, may be used for Condition A (supplementary reinforcement present). If the load combinations of ACI 318-11 Appendix C are used, the appropriate strength reduction factor must be determined in accordance with ACI 318-11 D4.4(a) or D.4.4(c) for Condition B (supplementary reinforcement no present), as applicable.
- Where no value is reported for pullout strength, this resistance does not need to be considered.
- N/A = Not Applicable.



# ETB & ETB-S2 WEDGE ANCHORS

ZINC & STAINLESS STEEL



## INSTALLATION PARAMETERS

TABLE 5: ETB-S2 ANCHOR DESIGN INFORMATION<sup>1,3,4,5</sup> CONTINUED

CHARACTERISTIC	SYMBOL	UNITS	NOMINAL ANCHOR DIAMETER								
			1/4"	3/8"	1/2"		5/8"		3/4"		
<b>STEEL STRENGTH IN TENSION AND SHEAR</b>											
Minimum Specified Yield Strength (Threads)	$f_y$	psi (N/mm <sup>2</sup> )	76,100 (525)	70,600 (487)				76,100 (525)			
Minimum Specified Yield Strength (Neck)	$f_y$	psi (N/mm <sup>2</sup> )	87,300 (602)								
Minimum Specified Ultimate Strength (Threads)	$f_{ut}$	psi (N/mm <sup>2</sup> )	101,500 (700)	94,300 (650)				101,500 (700)			
Minimum Specified Ultimate Strength (Neck)	$f_{ut}$	psi (N/mm <sup>2</sup> )	101,500 (700)								
Steel Strength in Tension	$N_{sa}$	lb(kN)	2,599 (11.6)	6,229 (27.7)	11,388 (50.7)	11,388 (50.7)	16,627 (74.0)	16,627 (74.0)	24,218 (107.7)	24,218 (107.7)	
Strength Reduction Factor for Tension Steel Failure	$\phi_{sa}$	-	0.75								
Steel Strength in Shear	$V_{sa}$	lb(kN)	1,861 (8.3)	4,008 (17.8)	4,745 (21.1)	7,301 (32.5)	10,163 (45.2)	10,163 (45.2)	14,805 (65.9)	14,805 (65.9)	
Steel Strength in Shear, Seismic	$V_{sa,eq}$	lb(kN)	N/A	4,008 (17.8)	4,745 (21.1)	6,596 (29.3)	7,740 (34.4)	7,740 (34.4)	10,556 (47.0)	10,556 (47.0)	
Strength Reduction Factor for Steel Failure in Shear	$\phi_{sa}$	-	0.65								
<b>PULLOUT STRENGTH IN TENSION</b>											
Pullout Strength in Uncracked Concrete	$N_{p,uncr}$	lb(kN)	1,247 (5.6)	3,299 (14.7)	3,723 (16.6)	6,257 (27.8)	-	9,977 (44.4)	-	-	
Pullout Strength in Cracked Concrete	$N_{p,cr}$	lb(kN)	N/A	2,361 (10.5)	2,117 (9.4)	-	-	-	-	-	
Pullout Strength in Cracked Concrete, Seismic	$N_{eq}$	lb(kN)	N/A	2,361 (10.5)	2,117 (9.4)	-	-	-	-	-	
Anchor Category	1,2 or 3	-	1	1	1	1	1	1	1	1	
Strength Reduction Factor for Pullout Strength in Tension	$\phi_p$	-	0.65								

For SI: 1 inch = 25.4mm, 1lbf = 4.45N, 1 lb/in = 0.175 N/mm, 1 psi = 0.00689 MPa = 0.00689 N/mm<sup>2</sup>, 1 in<sup>2</sup> = 645 mm<sup>2</sup>

- The tabulated data is to be used in conjunction with the design criteria given in ACI 318 (-19 and -14) Chapter 17 or ACI 318-11 Appendix D.
- For the 2006 IBC:  $d_o$  replaces  $d_a$  and  $A_{se,N}$  replaces  $A_{se}$ .
- The strength reduction factors apply when the load combinations of Section 1605.1 of the 2021 INC or Section 1605.2 of the 2018, 2015, 2012, 2009 and 2006 IBC, ACI 318 (-19 and -14) Section 5.3 or ACI 318-11 Section 9.2 are used, and the requirements of ACI 318-19 17.5.3, ACI 318-14 17.3.3(c) or ACI 318-11 D.4.3(c), as applicable, for Condition B (supplementary reinforcement not present) are met. For installations where complying reinforcement can be verified, the applicable strength reduction factors described in ACI 318-19 17.5.3, ACI 318-14 17.3.3(c) or ACI 318-11 D.4.3(c), as applicable, may be used for Condition A (supplementary reinforcement present). If the load combinations of ACI 318-11 Appendix C are used, the appropriate strength reduction factor must be determined in accordance with ACI 318-11 D.4.4(a) or D.4.4(c) for Condition B (supplementary reinforcement not present), as applicable.
- Where no value is reported for pullout strength, this resistance does not need to be considered.
- N/A = Not Applicable.



**INSTALLATION PARAMETERS**

**TABLE 5: ETB-S2 ANCHOR DESIGN INFORMATION<sup>1,3,4,5</sup> CONTINUED**

CHARACTERISTIC	SYMBOL	UNITS	NOMINAL ANCHOR DIAMETER							
			1/4"	3/8"	1/2"	5/8"	3/4"	1/2"	5/8"	3/4"
<b>CONCRETE BREAKOUT STRENGTH IN TENSION</b>										
Effectiveness Factor for Uncracked Concrete	$k_{uncr}$	-	24	24	24	24	24	24	24	24
Effectiveness Factor for Cracked Concrete	$k_{cr}$	-	-	17	17	17	17	17	21	17
Strength Reduction Factor for Concrete Breakout Strength in Tension	$\phi_{cb}$	-	0.65							
Axial Stiffness in Service Load Range in Uncracked Concrete	$\beta_{uncr}$	lb/in (N/mm)	130,772 (22,902)	99,669 (17,455)	177,031 (31,003)	45,481 (7,965)	179,362 (31,411)	74,892 (13,116)	282,916 (49,546)	209,464 (36,683)
Axial Stiffness in Service Load Range in Cracked Concrete	$\beta_{cr}$	lb/in (N/mm)	N/A	38,385 (6,722)	70,569 (12,359)	41,385 (7,248)	71,270 (12,481)	43,709 (7,655)	154,605 (27,075)	120,824 (21,159)
Normalization Exponent, Uncracked Concrete	n	-	0.13	0.30	0.32	0.48	0.27	0.4	0.43	0.33
Normalization Exponent, Cracked Concrete	n	-	N/A	0.45	0.50	0.49	0.50	0.50	0.27	0.43
<b>CONCRETE BREAKOUT STRENGTH IN SHEAR</b>										
Nominal Diameter	$d_o^2$	in (mm)	1/4 (6.4)	3/8 (9.5)	1/2 (12.7)	1/2 (12.7)	5/8 (15.9)	5/8 (15.9)	3/4 (19.1)	3/4 (19.1)
Load Bearing Length of Anchor	$l_e$	in (mm)	1-1/2 (3.8)	2 (51)	2 (51)	3-1/4 (83)	2-3/4 (70)	4 (102)	3-1/4 (83)	4-3/4 (121)
Reduction Factor for Concrete Breakout Strength in Shear	$\phi_{cb}$	-	0.70							
<b>CONCRETE PRYOUT STRENGTH IN SHEAR</b>										
Coefficient for Pryout Strength	$k_{cp}$	-	1.0	1.0	1.0	2.0	2.0	2.0	2.0	2.0
Reduction Factor for Pryout Strength in Shear	$\phi_{cp}$	-	0.70							

For SI: 1 inch = 25.4mm, 1lb = 4.45N, 1 lb/in = 0.175 N/mm, 1 psi = 0.00689 MPa = 0.00689 N/mm<sup>2</sup>, 1 in<sup>2</sup> = 645 mm<sup>2</sup>

- The tabulated data is to be used in conjunction with the design criteria given in ACI 318 (-19 and -14) Chapter 17 or ACI 318-11 Appendix D.
- For the 2006 IBC:  $d_o$  replaces  $d_a$  and  $A_{se,N}$  replaces  $A_{se}$ .
- The strength reduction factors apply when the load combinations of Section 1605.1 of the 2021 INC or Section 1605.2 of the 2018, 2015, 2012, 2009 and 2006 IBC, ACI 318 (-19 and -14) Section 5.3 or ACI 318-11 Section 9.2 are used, and the requirements of ACI 318-19 17.5.3, ACI 318-14 17.3.3(c) or ACI 318-11 D.4.3(c), as applicable, for Condition B (supplementary reinforcement not present) are met. For installations where complying reinforcement can be verified, the applicable strength reduction factors described in ACI 318-19 17.5.3, ACI 318-14 17.3.3(c) or ACI 318-11 D.4.3(c), as applicable, may be used for Condition A (supplementary reinforcement present). If the load combinations of ACI 318-11 Appendix C are used, the appropriate strength reduction factor must be determined in accordance with ACI 318-11 D4.4(a) or D.4.4(c) for Condition B (supplementary reinforcement no present), as applicable.
- Where no value is reported for pullout strength, this resistance does not need to be considered.
- N/A = Not Applicable.

## INSTALLATION INSTRUCTIONS

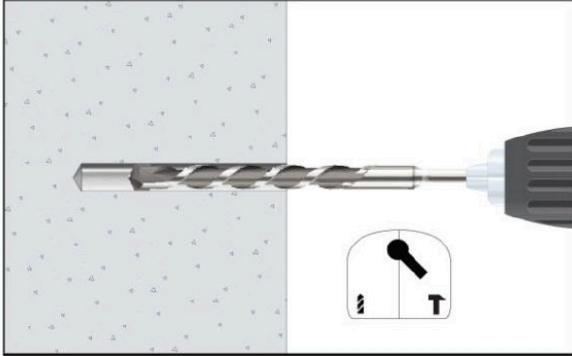

### 1. DRILL

Drill a hole into the base material of the correct diameter and depth using a drill bit that meets the requirements of ANSI B212.15

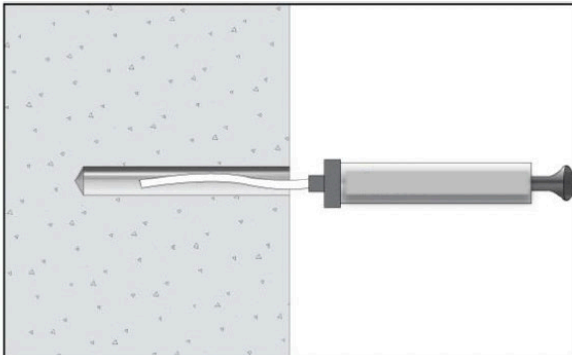

### 2. BLOW AND CLEAR

Remove dust and debris from hole using a hand pump, compressed air or a vacuum to remove loose particles left from drilling.

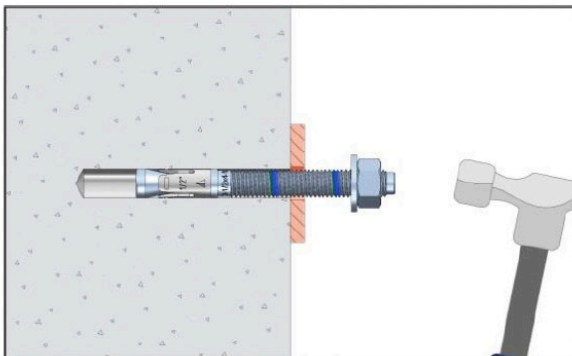

### 3. INSTALL

Position the washer on the anchor and thread the nut. If installing through a fixture drive the anchor through the fixture into the hole. Be sure the anchor is driven until the corresponding blue mark depth is leveled with the base material surface.

Use a hammer if necessary.

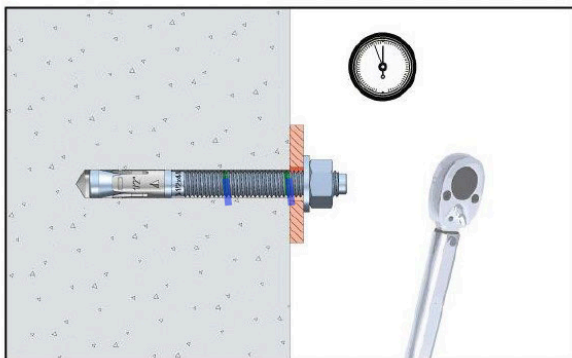

### 4. APPLY TORQUE

Tighten the anchor with a torque wrench by applying the required installation torque,  $T_{ins}$ . Note: the threaded stud will draw up during tightening of the nut; the expansion wedge (clip) remains in the original position.

Once installed, the total length of the anchor may be checked using the letter on the head.



**MATERIAL SPECIFICATIONS**

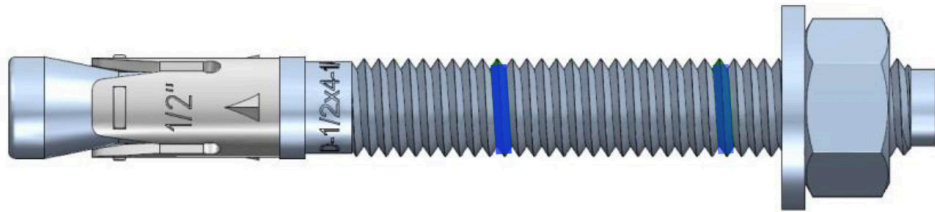

FIGURE 3—ETB AND ETB-S2 WEDGE ANCHOR

**TABLE 6: EXAMPLE ALLOWABLE STRESS DESIGN VALUES FOR ILLUSTRATIVE PURPOSES<sup>1,2,3,4,5,6,7,8,9,10</sup>**

NOMINAL ANCHOR DIAMETER $d_o$ (inch)	EFFECTIVE EMBEDMENT DEPTH $h_{ef}$ (inch)	$T_{ALLOWABLE,ASD}$ (lb)
1/4	1-1/2	692
3/8	2	1,460
1/2	2	1,491
1/2	3-1/4	2,513
5/8	2-3/4	2,403
5/8	4	4,216
3/4	3-1/4	3,474
3/4	4-3/4	5,456

1. Single anchor.
2. Static tension loading only.
3. Concrete determined to remain uncracked for the life of the anchorage.
4. Load combinations taken from ACI 318 (-19 and -14) Section 5.3 or ACI 318-11 Section 9.2, as applicable with no seismic loading.
5. 30% Dead Load (D) and 70% Live Load (L), controlling load combination 1.2D + 1.6L.
6. Calculation of the weighted average for  $\alpha = 1.2 \times 0.3 + 1.6 \times 0.7 = 1.48$
7. Normal weight concrete,  $f'_c = 2,500$  psi.
8.  $c_a = c_{a2} \geq c_{ac}$
9. Concrete thickness  $h \geq h_{min}$
10. Values are for Condition B (supplementary reinforcement not present) in accordance with ACI 318-19 17.5.3, ACI 318-14 7.3.3 or ACI 318-11 D.4.3, as applicable.

## MATERIAL SPECIFICATIONS

### Illustrative procedure of Allowable Stress Design calculation. Method ACI 318-19, Chapter 17

Per the figure below and the following information:

- 2 anchors ETB 1/2" x 4-1/2" anchor length
- Concrete strength 4,000 psi, cracked, 6-1/2" thick
- hef = 3-1/4 in
- Anchor Layout: as per sketch
- Static or quasi-static loads

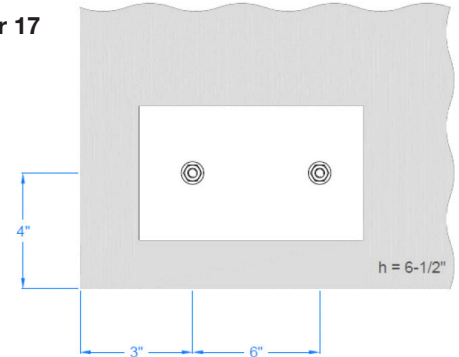

Step	ACI 318-19 Section Reference	ESR Section Reference	CALCULATIONS
1	17.9	Section 4.1.11 Table 1	Verify spacing / edge distance / member thickness $c_{a1} = 3$ in with $s = 6$ in $> 2-1/2$ in with $s = 6$ in → verified $c_{a2} = 4$ in with $s = 6$ in $> 2-1/2$ in with $s = 6$ in → verified $h = 6-1/2$ in $> 6$ in → verified
2	17.6.1.2	Section 4.1.2 Table 2	Calculate steel capacity on a single fastener loaded in tension $\phi N_{sa} = (0.75) (10,600) = 7,950$ lbf Group of fasteners $\phi N_s = n \phi N_{sa} = (2) (7,950) = \mathbf{15,900}$ lbf
3	17.6.2.1	4.1.3	Calculate concrete strength capacity on the group of fasteners loaded in tension $\phi N_{cbg} = \phi \frac{A_{Nc}}{A_{Nco}} \psi_{ec,N} \psi_{ed,N} \psi_{c,N} \psi_{cp,N} N_b$
3.1	17.6.2.1	Table 4	$A_{Nc} = (c_{a1} + 1.5 h_{ef}) (c_{a2} + s + 1.5 h_{ef}) = (4 + 4.88) (3 + 6 + 4.88) = 123.25$ $A_{Nco} = 9 (h_{ef})^2 = 9 (3.25)^2 = 95.06$
3.2	17.6.2.3		No load eccentricity → $e_v = 0$ → $\psi_{ec,N} = 1.00$
3.3	17.6.2.4	Table 1	$C_{a,min} < 1.5 h_{ef} \rightarrow \psi_{ed,N} = 0.7 + 0.3 \frac{c_{a,min}}{1.5 h_{ef}} = 0.7 + 0.3 \frac{3}{4.88} = 0.88$
3.4	17.6.2.5		Cracked concrete → $\psi_{c,N} = 1.00$
3.5	17.6.2.6		Cracked concrete → $\psi_{cp,N} = 1.00$
3.6	17.6.2.2	4.1.3	$N_b = k_c \lambda_a \sqrt{f'_c} h_{ef}^{1.5} = (17) (1.0) \sqrt{4000} (3.25)^{1.5} = 6,299$ lbf
	17.6.2.1	4.1.3	thus $\phi N_{cbg} = (0.65) \frac{123.25}{95.06} (1.0)(0.88)(1.0)(6,299) = \mathbf{4,671}$ lbf
4	17.6.3.1	Section 4.1.4 Table 4	Calculate pull out strength on single fastener loaded in tension $\phi N_{p,f} = \phi \psi_{c,p} N_{p,2500} \left( \frac{f'_c}{2,500} \right)^n = (0.65)(1.00) (4,252) \left( \frac{4,000}{2,500} \right)^{0.46} = 3,430$ lbf Group of fasteners $\phi N_p = n \phi N_{p,f} = (2) (3,430) = \mathbf{6,860}$ lbf
5	17.5.2		Governing tension strength: Minimum value of steel, concrete breakout, pull out: $\phi N_n = \min [\phi N_s; \phi N_c; \phi N_p] = \mathbf{4,671}$ lbf
6	5.3	Section 4.2.1	Calculation of conversion factor, $\alpha$ , to allowable stress design $\alpha = (1.2) D + (1.6) L = (1.2) (0.30) + (1.6) (0.6) = \mathbf{1.48}$
7	-	Section 4.2.1	Calculation of allowable stress design in tension: $T_{allowable,ASD} = \frac{\phi N_n}{\alpha} = \frac{4,671}{1.48} = \mathbf{3,156}$ lbf

**ETB & ETB-S2 WEDGE ANCHORS**  
ZINC & STAINLESS STEEL**ORDERING INFORMATION****TABLE 7: ETB WEDGE ANCHOR ORDERING INFORMATION**

PART NUMBER	DESCRIPTION DIA. X L	DRILL SIZE	QTY/BOX
1ETB14134	1/4" x 1-3/4"	1/4"	100
1ETB14214	1/4" x 2-1/4"	1/4"	100
1ETB14314	1/4" x 3-1/2"	1/4"	100
1ETB38214	3/8" x 2-1/4"	3/8"	50
1ETB38234	3/8" x 2-3/4"	3/8"	50
1ETB38300	3/8" x 3"	3/8"	50
1ETB38312	3/8" x 3-1/2"	3/8"	50
1ETB38334	3/8" x 3-3/4"	3/8"	50
1ETB38500	3/8" x 5"	3/8"	50
1ETB12234	1/2" x 2-3/4"	1/2"	50
1ETB12334	1/2" x 3-3/4"	1/2"	25
1ETB12412	1/2" x 4-1/2"	1/2"	20
1ETB12512	1/2" x 5-1/2"	1/2"	20
1ETB12700	1/2" x 7"	1/2"	20
1ETB58312	5/8" x 3-1/2"	5/8"	25
1ETB58412	5/8" x 4-1/2"	5/8"	25
1ETB58500	5/8" x 5"	5/8"	25
1ETB58600	5/8" x 6"	5/8"	10
1ETB58700	5/8" x 7"	5/8"	10
1ETB58812	5/8" x 8-1/2"	5/8"	10
1ETB34414	3/4" x 4-1/4"	3/4"	10
1ETB34434	3/4" x 4-3/4"	3/4"	10
1ETB34512	3/4" x 5-1/2"	3/4"	10
1ETB34614	3/4" x 6-1/4"	3/4"	10
1ETB34700	3/4" x 7"	3/4"	10
1ETB34812	3/4" x 8-1/2"	3/4"	10

**ETB & ETB-S2 WEDGE ANCHORS**

ZINC &amp; STAINLESS STEEL

**ORDERING INFORMATION****TABLE 8: ETB-S2 WEDGE ANCHOR ORDERING INFORMATION**

PART NUMBER	DESCRIPTION DIA. X L	DRILL SIZE	QTY/BOX
1ETBS214214	1/4" x 2-1/4"	1/4"	100
1ETBS214314	1/4" x 3-1/4"	1/4"	100
1ETBS238214	3/8" x 2-1/4"	3/8"	50
1ETBS238300	3/8" x 3"	3/8"	50
1ETBS238334	3/8" x 3-3/4"	3/8"	50
1ETBS238500	3/8" x 5"	3/8"	50
1ETBS212334	1/2" x 3-3/4"	1/2"	25
1ETBS212412	1/2" x 4-1/2"	1/2"	20
1ETBS212512	1/2" x 5-1/2"	1/2"	20
1ETBS212700	1/2" x 7"	1/2"	20
1ETBS212812	1/2" x 8-1/2"	1/2"	20
1ETBS258412	5/8" x 4-1/2"	5/8"	25
1ETBS258500	5/8" x 5"	5/8"	25
1ETBS234512	3/4" x 5-1/2"	3/4"	10
1ETBS234614	3/4" x 6-1/4"	3/4"	10



## ESR-4346 LABC AND LARC SUPPLEMENT

### 1.0 REPORT PURPOSE & SCOPE

**DIVISION: 03 00 00—CONCRETE****Section: 03 16 00—Concrete Anchors****DIVISION: 05 00 00—METAL****Section: 05 05 19—Post-Installed Concrete Anchors**

The purpose of this evaluation report supplement is to indicate that ETB and ETB-S2 Wedge Anchors for cracked and uncracked concrete, described in ICC-ES evaluation report ESR 4346, have also been evaluated for compliance with the codes noted below as adopted by the Los Angeles Department of Building and Safety (LADBS)

**Applicable Code Editions:**

- 2020 City of Los Angeles Building Code (LABC)
- 2020 City of Los Angeles Residential Code (LARC)

### 2.0 CONCLUSIONS

The ETB and ETB-S2 wedge anchors for cracked and uncracked concrete, described in Sections 2.0 through 7.0 of the evaluation report ESR-4346, comply with LABC Chapter 19, and the LARC, and are subject to the conditions of use described in this supplement.

### 3.0 CONDITIONS OF USE

The ETB and ETB-S2 wedge anchors for cracked and uncracked concrete, described in this evaluation report supplement must comply with all the following conditions:

- All applicable sections in the evaluation report ESR-4346.
- The design, installation, conditions, of use and identification of the screw anchors are in accordance with the 2018 International Building Code (IBC) provisions noted in the evaluation report ESR-4346.
- The design, installation and inspection are in accordance with additional requirements of LABC Chapters 16 and 17, and City of Los Angeles Building Information Bulletin P/BC 2020-092, as applicable. References to Los Angeles Research Reports (LARR) within the COLA Information Bulletin P/BC may be substituted with this supplement.
- Under the LARC, an engineered design in accordance with LARC Section R301.1.3 must be submitted.
- The allowable strength and design strength values listed in the evaluation report and table are for the connection of the anchors to the concrete. The connection between the anchors and the connected members must be checked for capacity (which may govern).
- For all in wall anchorage assemblies to flexible diaphragm applications, anchors must be designed per the requirements of City of Los Angeles Information Bulletin P/BC 2020-71.

This supplement expires concurrently with the evaluation report, reissued February 2024.



## ESR-4346 CBC AND CRC SUPPLEMENT

### 1.0 REPORT PURPOSE & SCOPE

**DIVISION: 03 00 00—CONCRETE****Section: 03 16 00—Concrete Anchors****DIVISION: 05 00 00—METAL****Section: 05 05 19—Post-Installed Concrete Anchors**

The purpose of this evaluation report supplement is to indicate that ETB and ETB-S2 wedge anchors for cracked and uncracked concrete, described in ICC-ES evaluation report ESR-4346, have also been evaluated for compliance with the codes noted below:

**Applicable Code Editions:**

- 2019 California Building Code (CBC)

For evaluation of applicable chapters adopted by the California Office of Statewide Health Planning and Development (OSHPD) AKA: California Department of Health Care Access and Information (HCAI) and the Division of the State Architect (DSA), see Sections 2.1.1 and 2.1.2 below.

- 2019 California Residential Code (CRC)

### 2.0 CONCLUSIONS

- 2.1 CBC:** The ETB and ETB-S2 wedge anchors for cracked and uncracked concrete, described in Sections 2.0 through 7.0 of the evaluation report ESR-4346, comply with CBC Chapter 19, provided the design and installation are in accordance with the 2018 International Building Code (IBC), provisions noted in the evaluation report, and the additional inspection requirements of the CBC Chapters 16, 17 and 19, as applicable.
- 2.1.1 OSHPD:** The applicable OSHPD Sections and Chapters of the CBC are beyond the scope of this supplement.
- 2.1.2 DSA:** The applicable DSA Sections and Chapters of the CBC are beyond the scope of this supplement.
- 2.2 CRC:** The ETB and ETB-S2 wedge anchors for cracked and uncracked concrete, described in Sections 2.0 through 7.0 of the evaluation report ESR-4346, comply with CRC Section R301.1.3, provided the design and installation are in accordance with the 2018 International Building Code (IBC) provisions noted in the evaluation report and the additional requirements of CBC Chapters 16, 17 and 19.

The supplement expires concurrently with the evaluation report, reissued February 2024.



## ESR-4346 FBC SUPPLEMENT

### 1.0 REPORT PURPOSE & SCOPE

**DIVISION: 03 00 00—CONCRETE****Section: 03 16 00—Concrete Anchors****DIVISION: 05 00 00—METAL****Section: 05 05 19—Post-Installed Concrete Anchors**

The purpose of this evaluation report supplement is to indicate that ETB and ETB-S2 wedge anchors for cracked and uncracked concrete, described in ICC-ES evaluation report ESR-4346, has also been evaluated for compliance with the codes noted below:

**Compliance with the Following Codes:**

- 2020 Florida Building Code - Building
- 2020 Florida Building Code - Residential

### 2.0 PURPOSE OF THIS SUPPLEMENT

The ETB and ETB-S2 wedge anchors for cracked and uncracked concrete, described in Sections 2.0 through 7.0 of ICC ES evaluation report ESR-4346, comply with the Florida Building Code - Building and Florida Building Code - Residential, provided the design requirements are determined in accordance with the Florida Building Code-Building or the Florida Building Code-Residential, as applicable. The installation requirements noted in ICC-ES evaluation report ESR-5175 for the 2018 International Building Code meet the requirements of the Florida Building Code-Building or the Florida Building Code-Residential, as applicable, with the following conditions.

Use of the ETB wedge anchor for cracked and uncracked concrete have also been found to be in compliance with the High-Velocity Hurricane Zone provisions of the Florida Building Code-Building and the Florida Building Code-Residential with the following condition:

- a.) For anchorage to wood members, the connection subject to uplift must be designed for no less than 700 pounds (3114 N).
- b.) For connection to aluminum members, all expansion anchors must be installed no less than 3 inches from the edge of concrete slab and/or footing. All expansion anchors shall develop an ultimate withdrawal resisting force equal to four times the imposed load, with no stress increase for duration of load.

For products falling under Florida Rule 61G20-3, verification that the report holder's quality assurance program is audited by a quality assurance entity approved by the Florida Building Commission for the type of inspections being conducted is the responsibility of an approved validation entity (or the code official when the report holder does not possess an approval by the Commission).

This supplement expires concurrently with the evaluation report, reissued February 2024.

**ETB & ETB-S2 WEDGE ANCHORS**

ZINC &amp; STAINLESS STEEL



ICC ESR-4346 &amp; 5642

**DISCLAIMER**

**IMPORTANT:** Information, specifications, procedures and recommendations provided (“information”) are based on our experience and we believe this to be accurate. No representation, guarantee or warranty is made as to the accuracy or completeness of the information or that use of the product will avoid losses or damages or give desired results. It is purchaser’s sole responsibility to test and determine the suitability of any product for the intended use. Tests should be repeated if materials or conditions change in any way. No employee, distributor or agent has any right to change these facts and offer a guarantee of performance.

**NOTE TO USER:** by ordering/receiving product you accept the ALLFASTENERS General Terms and Conditions of Sale applicable in the region. Please request a copy if you have not received these. These Terms and Conditions contain disclaimers of implied warranties (including but not limited to disclaiming warranties of fitness for a particular purpose) and limits of liability.